

ESCRITORIO INDUSTRIAL

Instructivo de Armado

LIE110

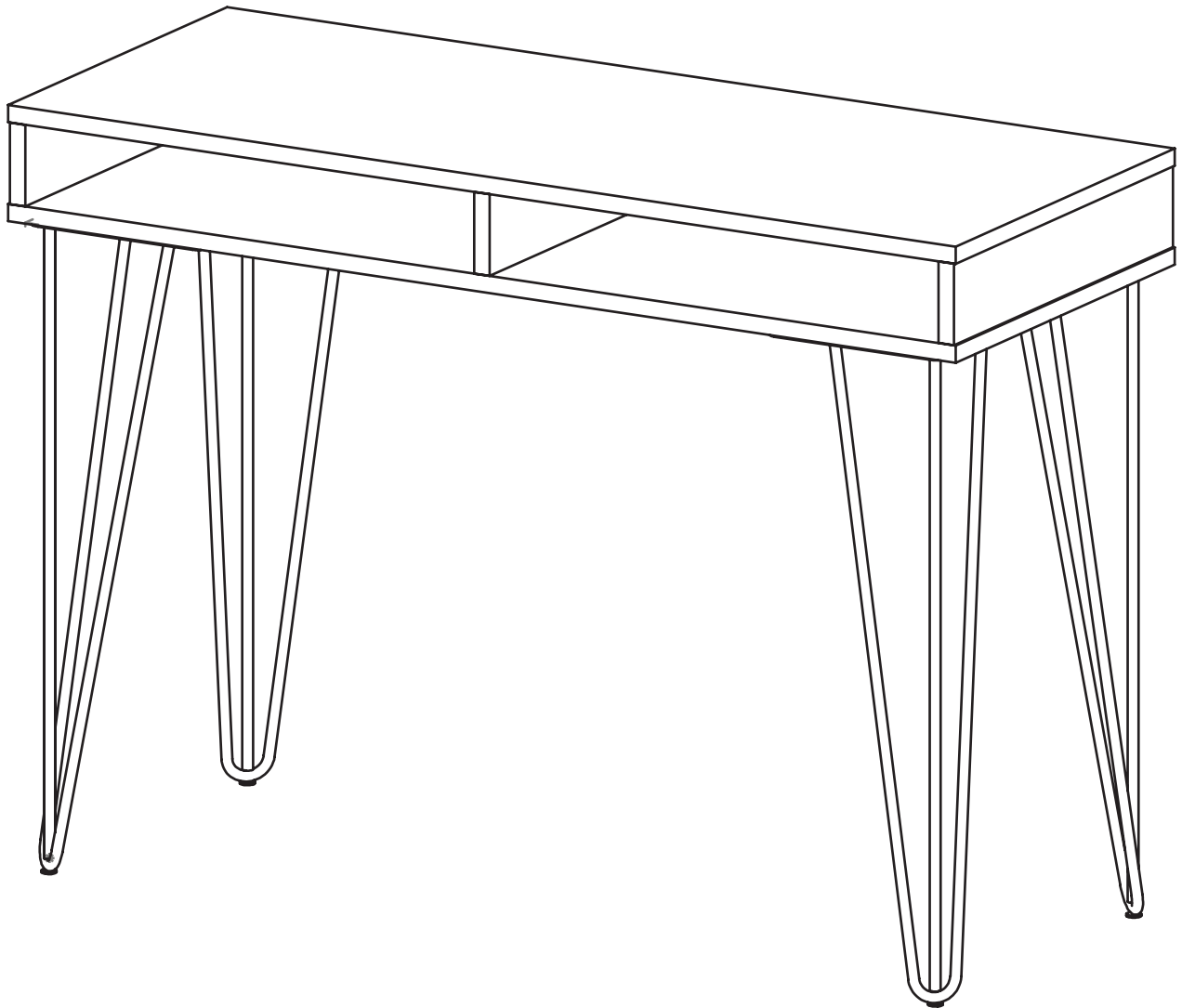

ESCANEA Y MIRA EL VIDEO DE ARMADO

DIELFE



✉ posventa@dielfe.com.ar

📌 [dieflemuebles](#)

📘 www.facebook.com/dielfe

📷 [dielfemuebles](#)

www.dielfe.com.ar

Industria Argentina

COMPONENTES

TAPA (T)
CANTIDAD: 1

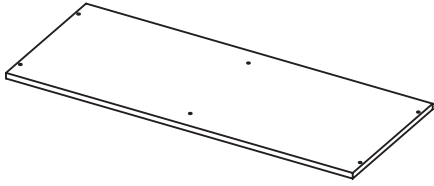

BASE (B)
CANTIDAD: 1

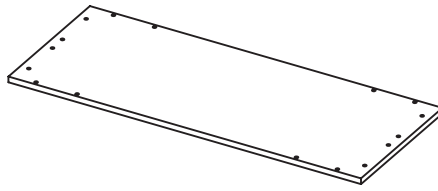

COSTADO (CDV)
CANTIDAD: 3

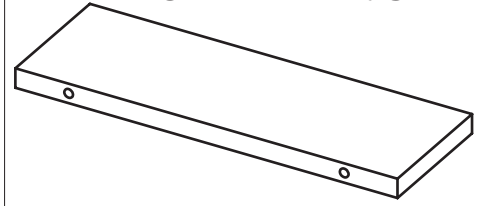

PATA
CANTIDAD: 4

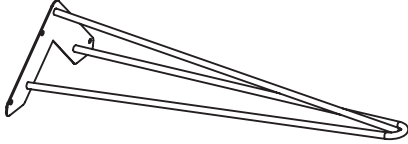

Nota: Los bordes pintados en gris hacen referencia a los filos de la melamina.

HERRAJES

TARUGO 8x30
CANTIDAD: 6



SACHE COLA
CANTIDAD: 2

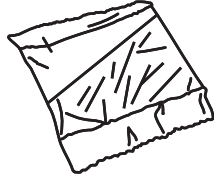

INSERTO PLASTICO
CANTIDAD: 16

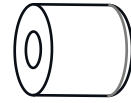

TORNILLO 4,2x19 (A)
CANTIDAD: 16

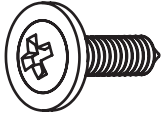

TORNILLO 3.5x35
C.CHATA (B)
CANTIDAD: 9

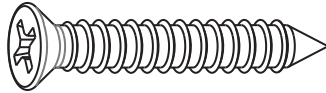

HERRAMIENTAS NECESARIAS NO PROVISTAS

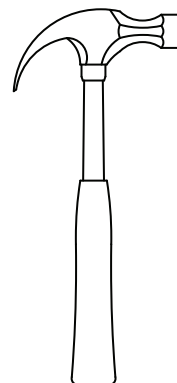
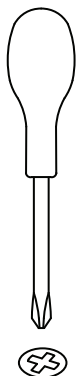

1

Colocar los insertos plasticos a presion como se muestra a continuacion.

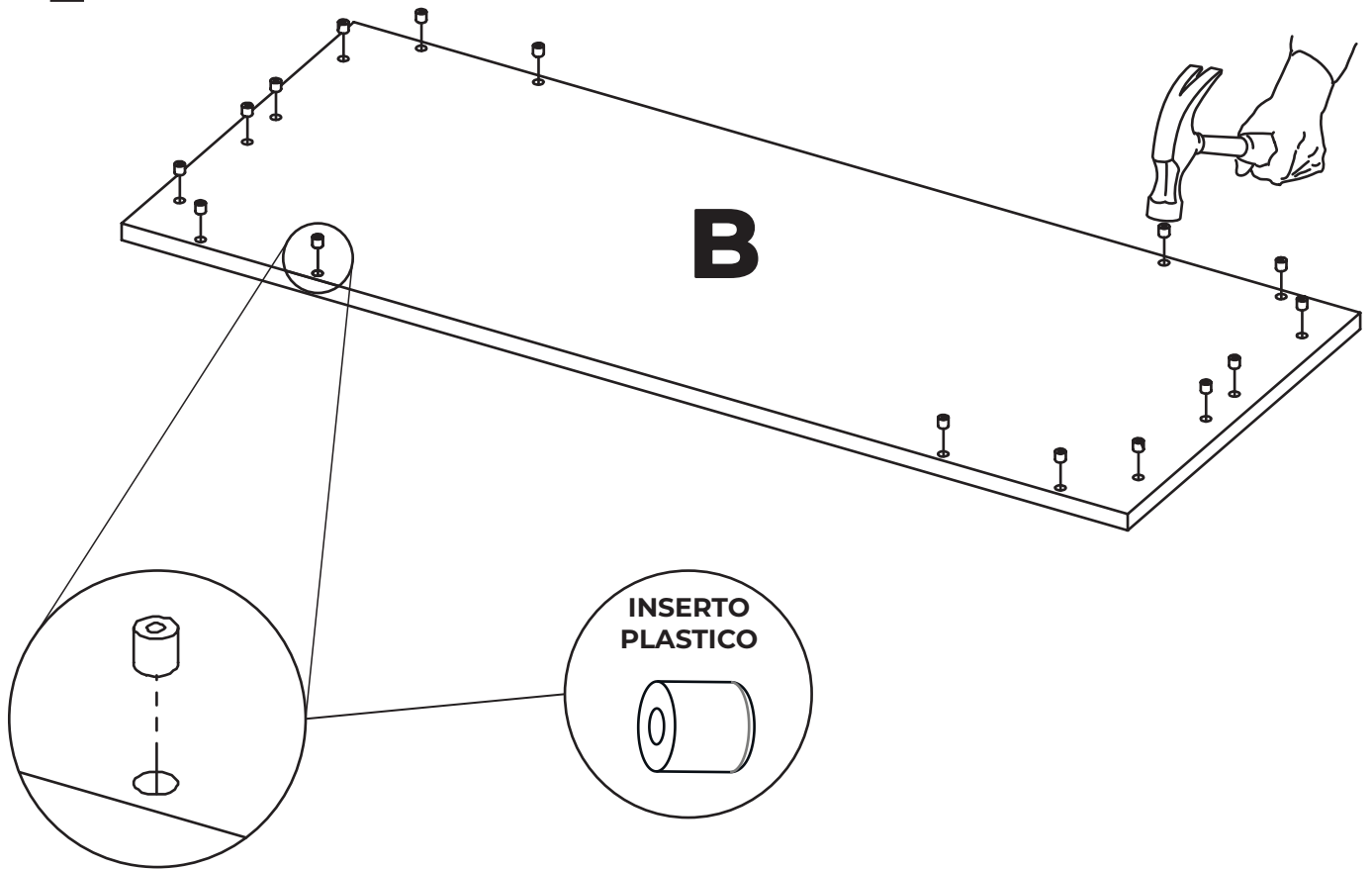

2

Colocar los tarugos en los costados y divisor vertical (CDV). Previamente encolar los agujeros que alojan los tarugos. Luego vincular estas piezas a la tapa (T), previamente encolados los agujeros.

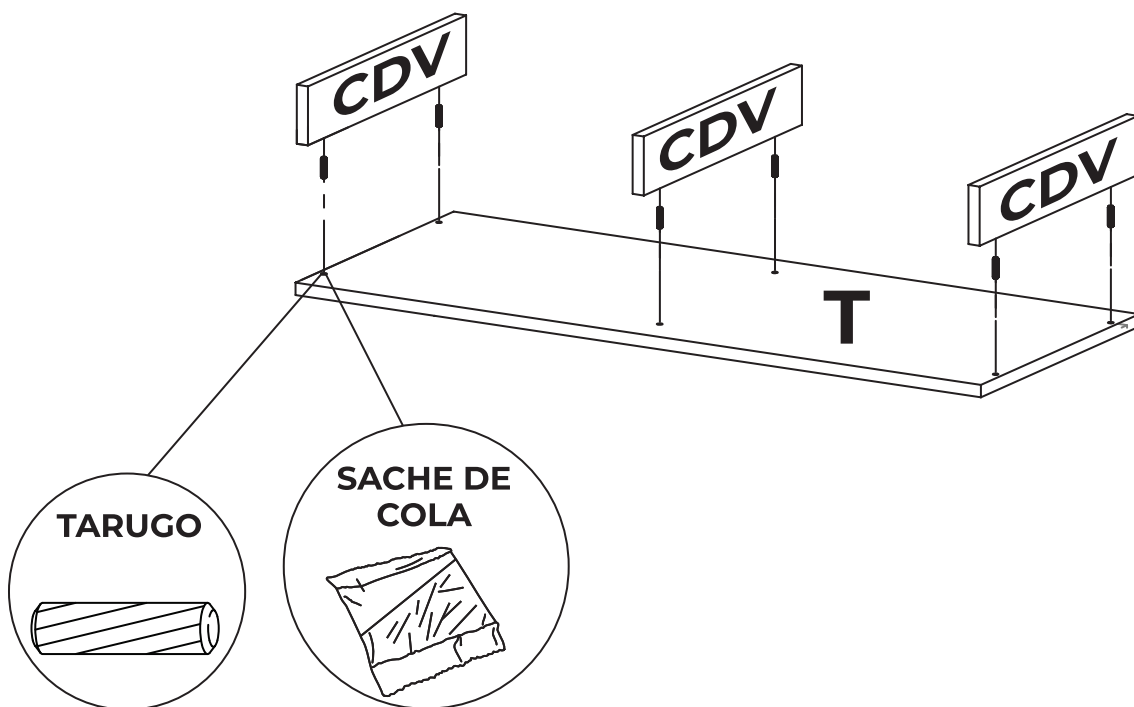

3

Centrar la base (B) en la estructura y colocar los tornillos (B).

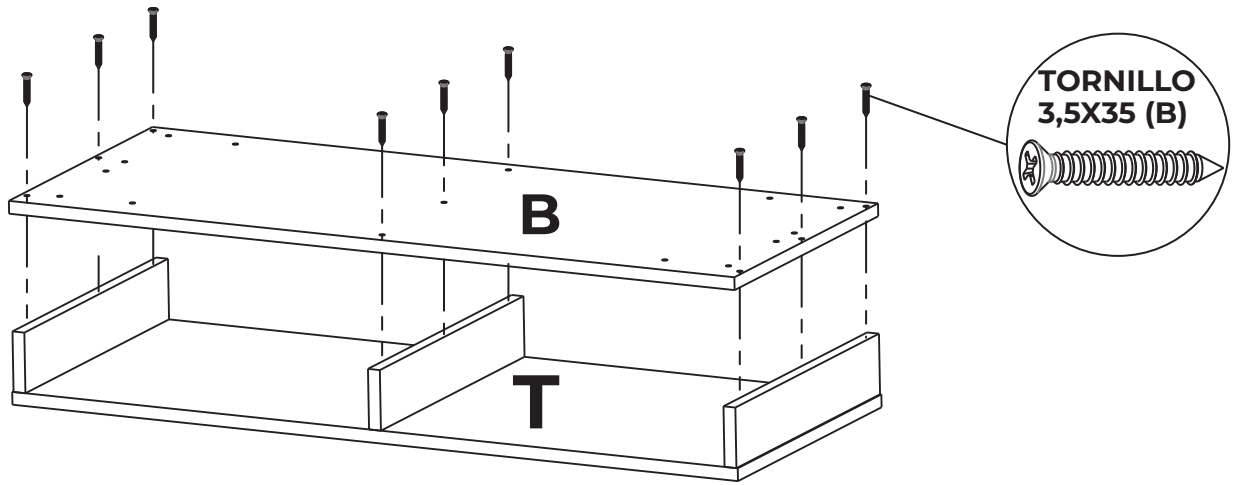

4

Posicionar las patas sobre la base (B) y atornillar con los tornillos (A) como se muestra a continuación.

