

PLACARD

Instructivo de Armado

PL 180



Rev. 1-04/10/2021

DIELFE[®]

Fabricamos tu mueble

ESCANEA Y MIRA EL VIDEO DE ARMADO



✉ posventa@dielfe.com.ar

📌 [dieflemuebles](#)

📘 www.facebook.com/dielfe

📷 [dielfemuebles](#)

www.dielfe.com.ar

Industria Argentina

COMPONENTES

**COSTADO DERECHO
(CD)
CANTIDAD: 1**

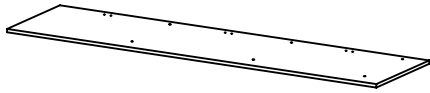

**COSTADO IZQUIERDO
(CI)
CANTIDAD: 1**

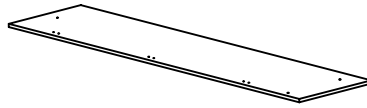

**DIVISOR HORIZONTAL
(DH)
CANTIDAD: 5**

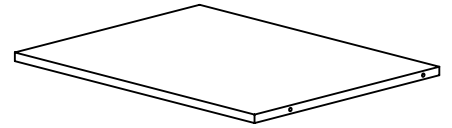

**DIVISOR VERTICAL
DERECHO (DVD)
CANTIDAD: 1**

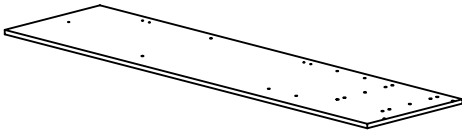

**DIVISOR VERTICAL
IZQUIERDO (DVI)
CANTIDAD: 1**

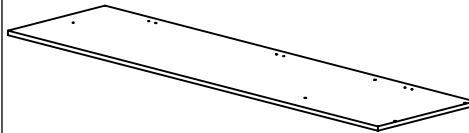

**PUERTA CHICA (PCH)
CANTIDAD: 2**

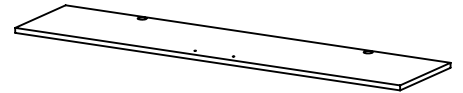

**PUERTA GRANDE (PG)
CANTIDAD: 4**

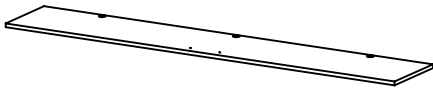

**TAPA (T)
CANTIDAD: 1**

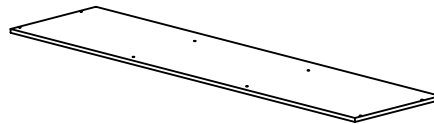

**ZOCALO (Z)
CANTIDAD: 2**

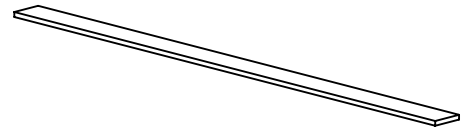

**COSTADO CAJON (CC)
CANTIDAD: 4**

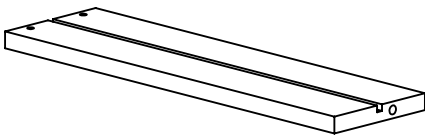

**CONTRA FRENTE
CAJON (CFC)
CANTIDAD: 2**

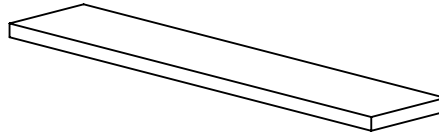

**FRENTE CAJON (FC)
CANTIDAD: 2**

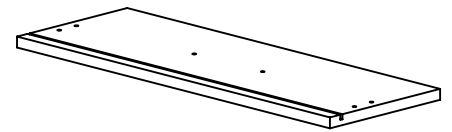

**FONDO CAJON (FOC)
CANTIDAD: 2**

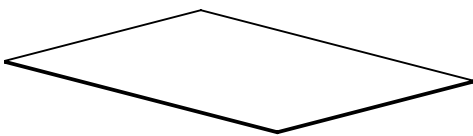

**FONDO (FO)
CANTIDAD: 6**



Nota: Los bordes pintados en gris hacen referencia a los filos de la melamina.

HERRAJES

REGATON U
CANTIDAD: 8

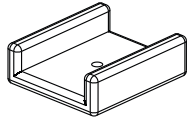

L PLASTICA
CANTIDAD: 12

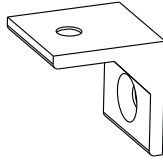

JUEGO DE COLIZAS
CANTIDAD: 2

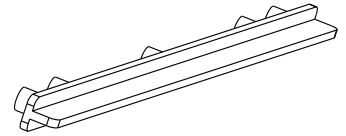

TORNILLO 3,5x14 (A)
CANTIDAD: 96

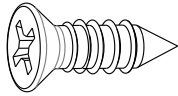

TORNILLO 3,5x30 (B)
CANTIDAD: 24

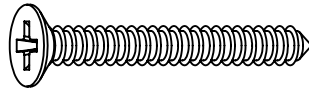

TORNILLO ARMADOR
7x50 (C)
CANTIDAD: 28

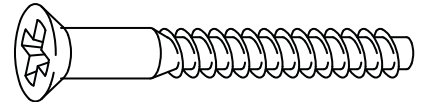

CLAVOS 8x20
CANTIDAD: 180

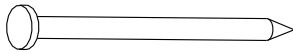

CONJUNTO MINI FIX
CANTIDAD: 4

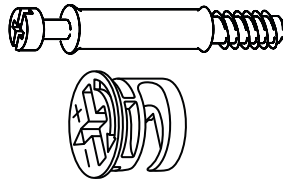

BISAGRA
CANTIDAD: 16

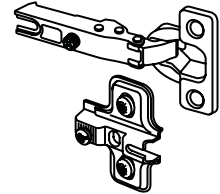

MANIJA
CANTIDAD: 8

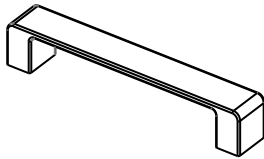

SOPORTE PERCHERO
CANTIDAD: 4

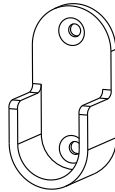

PERCHERO
CANTIDAD: 2

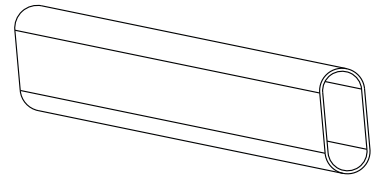

H VINCULANTE
CANTIDAD: 3



SACHE COLA
CANTIDAD: 1

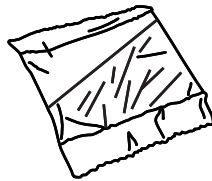

HERRAMIENTAS NECESARIAS NO PROVISTAS

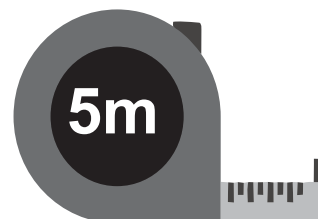
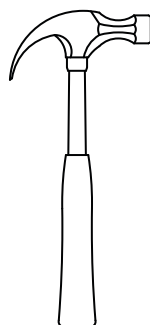
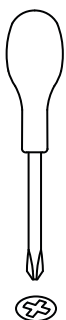

3 Armar la estructura del cajon como se muestra a continuacion uniendo el frente cajon (FC), con los costados del cajon (CC) y estos con el contra frente cajon (CFC). Luego colocar la manija con el tornillo correspondiente.

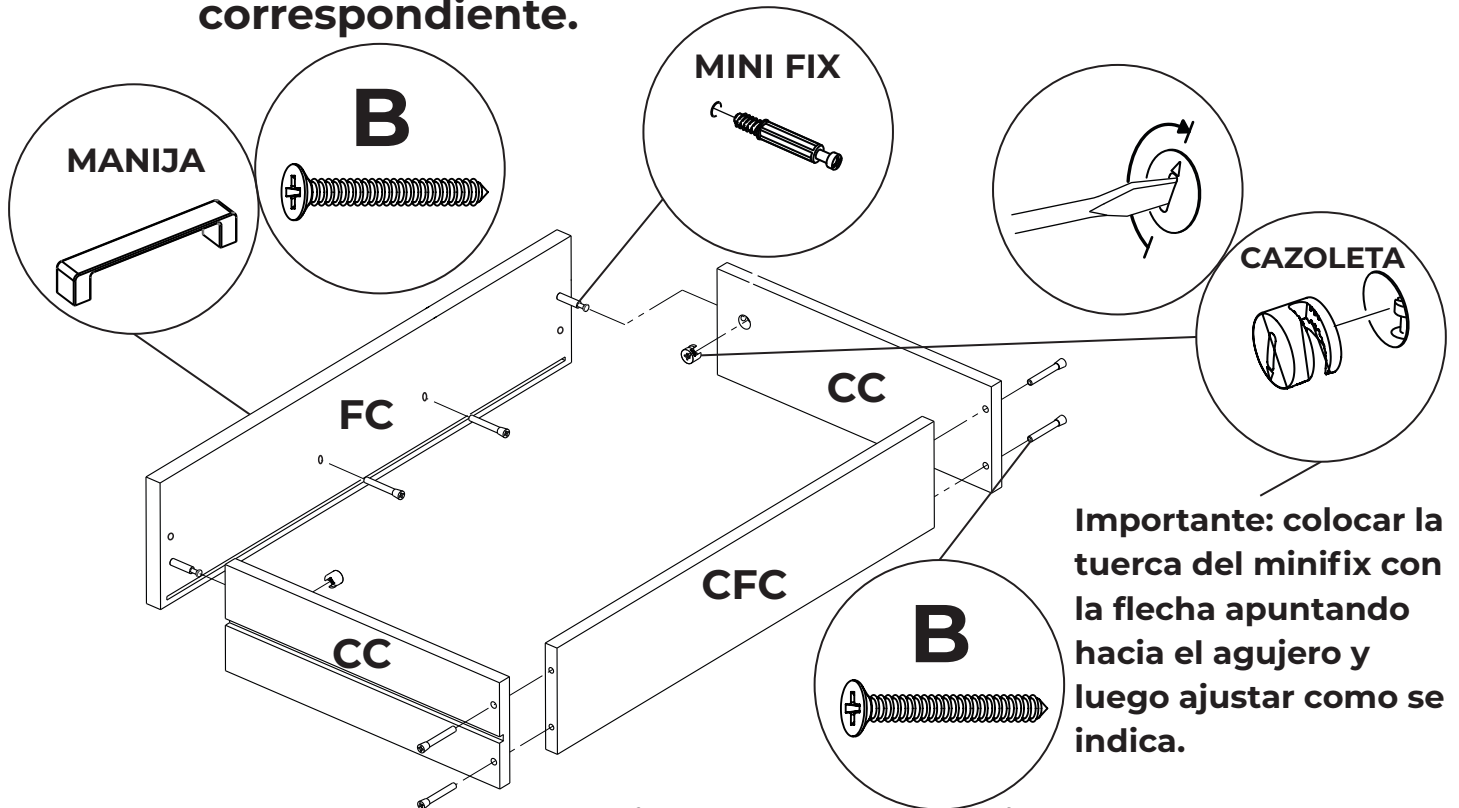

4 Colocar el fondo de cajon y clavar para afirmar las partes.

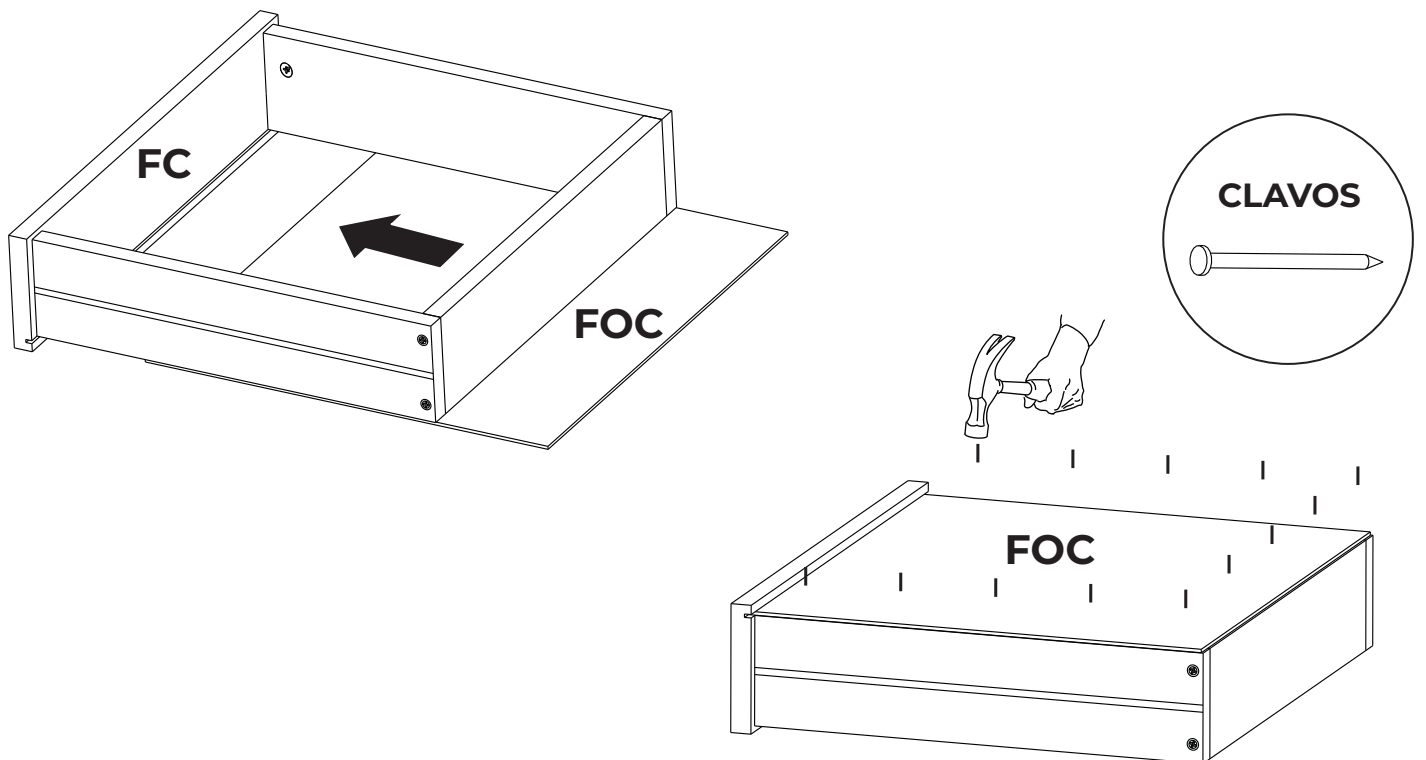

5

Colocar el juego de colizas donde se ubicaran los cajones. Previamente encolar los agujeros que alojan las colizas.

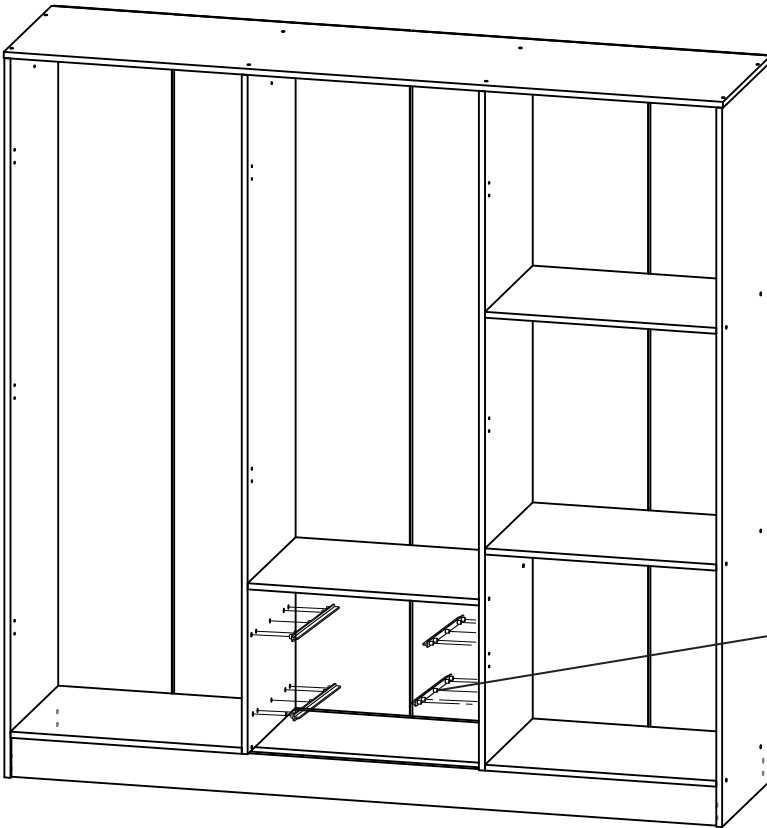

SACHE DE COLA



COLIZAS

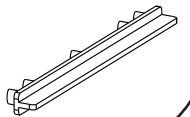

6

Colocar las bisagras en las puertas (PG-PCH) y los tiradores como se indican a continuacion con los tornillos indicados.

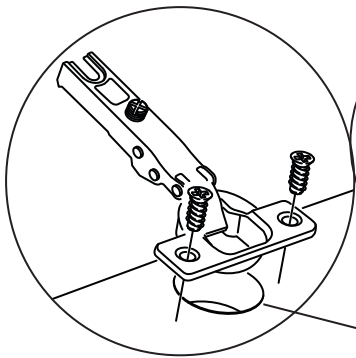

A

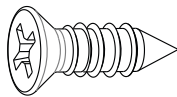

PG

MANIJAS

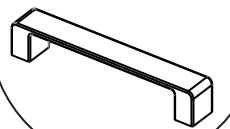

B



PCH

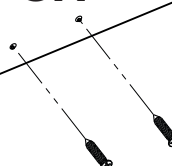

7

Colocar las puertas con las bisagras como se indica a continuación. Luego colocar el soporte de perchero en ambos lados para poder

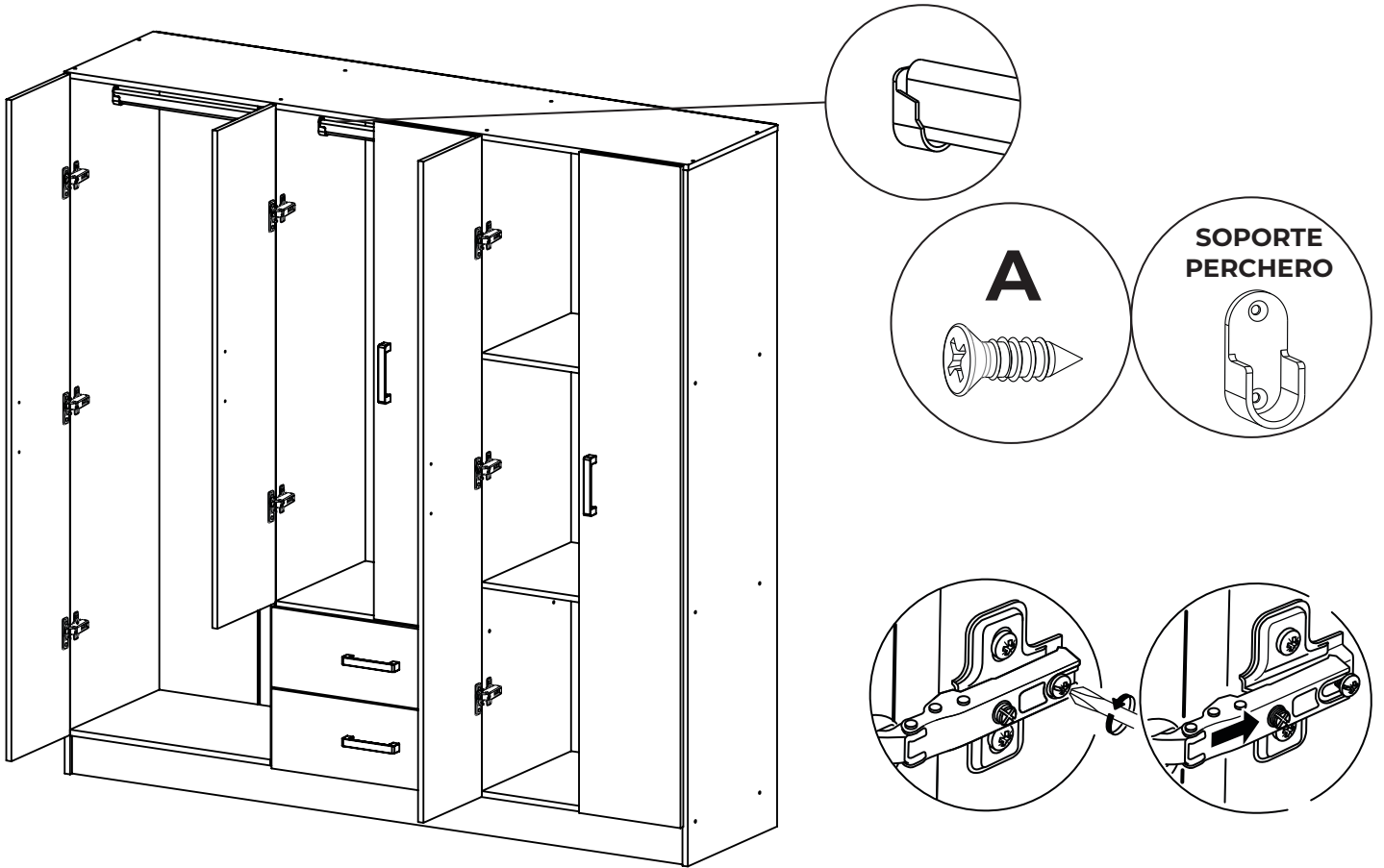

Regulación de bisagras

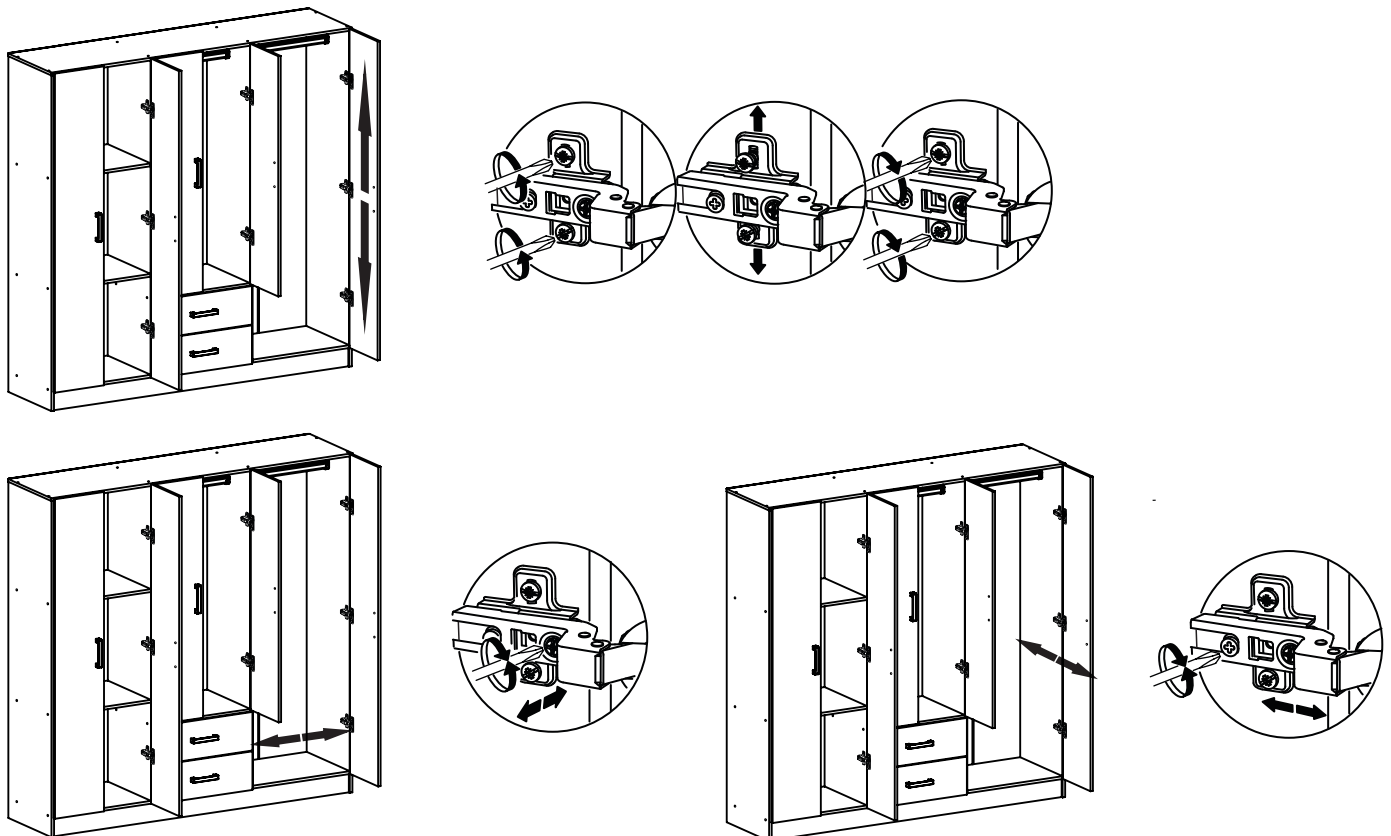

Regulacion de bisagras

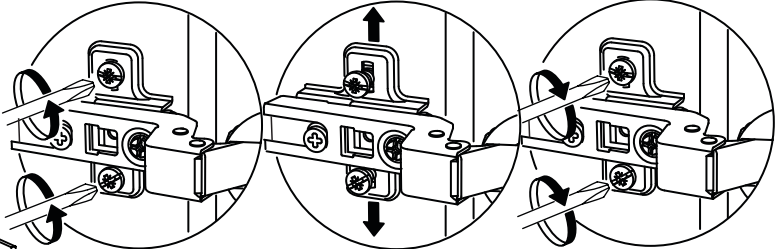
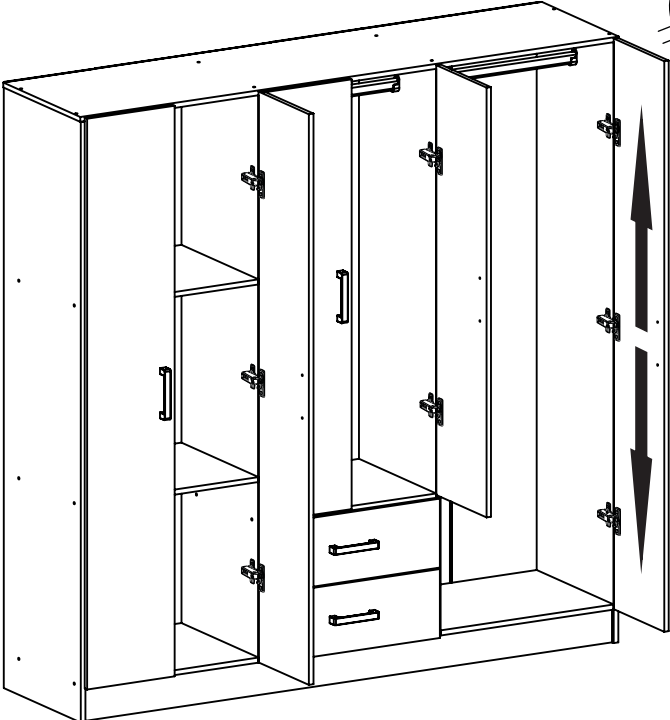

Regulacion de bisagras

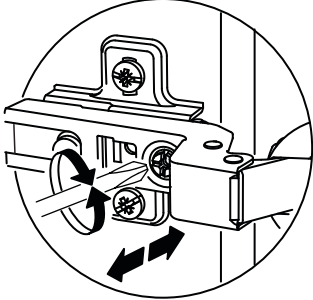

Regulacion de bisagras

