

PLACARD

Instructivo de Armado

PL 060

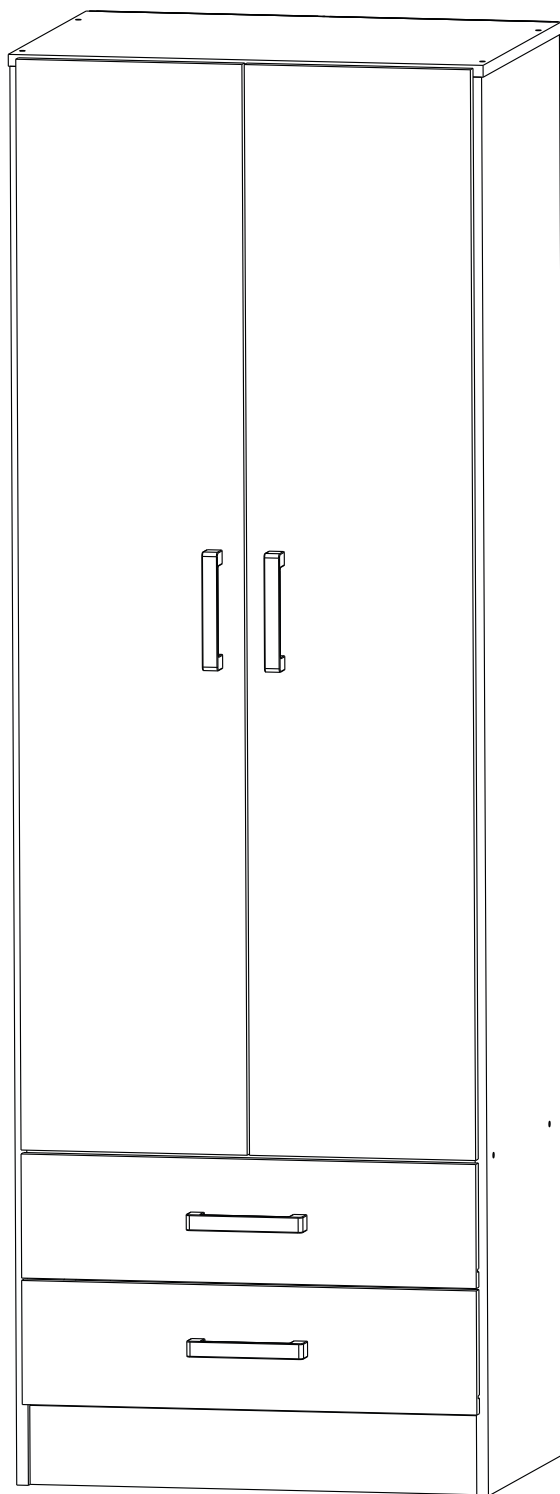

Rev. 1-04/10/2021

DIELFE[®]

Fabricamos tu mueble

ESCANEA Y MIRA EL VIDEO DE ARMADO



✉ posventa@dielfe.com.ar

📌 [dieflemuebles](#)

📘 www.facebook.com/dielfe

📷 [dielfemuebles](#)

www.dielfe.com.ar

Industria Argentina

COMPONENTES

**COSTADO DERECHO
(CD)
CANTIDAD: 1**

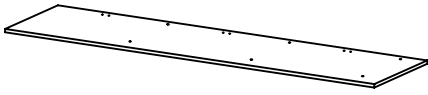

**COSTADO IZQUIERDO
(CI)
CANTIDAD: 1**

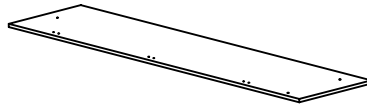

**DIVISOR HORIZONTAL
(DH)
CANTIDAD: 1**

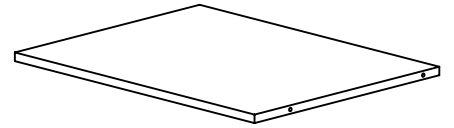

**COSTADO CAJON (CC)
CANTIDAD: 4**

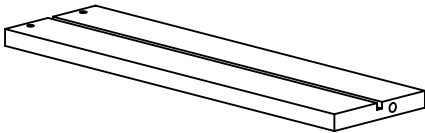

**FONDO (FO)
CANTIDAD: 2**



**PUERTA CHICA (PCH)
CANTIDAD: 2**

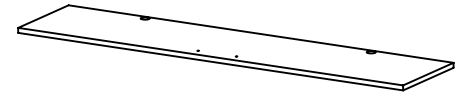

**FONDO CAJON (FOC)
CANTIDAD: 2**

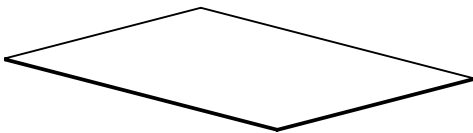

**TAPA (T)
CANTIDAD: 1**

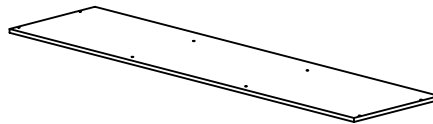

**ZOCALO (Z)
CANTIDAD: 2**

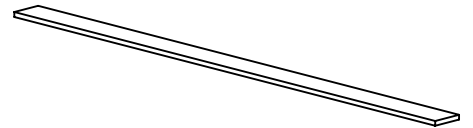

**CONTRA FRENTE
CAJON (CFC)
CANTIDAD: 2**

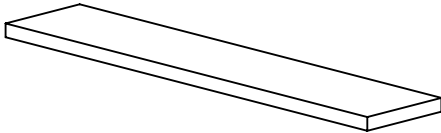

**FRENTE CAJON (FC)
CANTIDAD: 2**

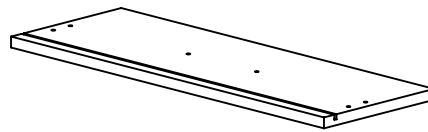

Nota: Los bordes pintados en gris hacen referencia a los filos de la melamina.

HERRAJES

REGATON U
CANTIDAD: 6

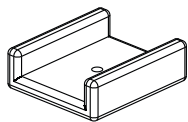

L PLASTICA
CANTIDAD: 8

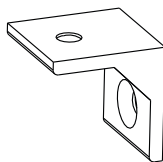

COLIZAS PLASTICAS
CANTIDAD: 4

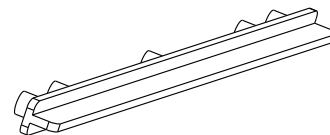

TORNILLO 3,5x14 (A)
CANTIDAD: 38

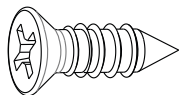

TORNILLO 3,5x30 (B)
CANTIDAD: 16

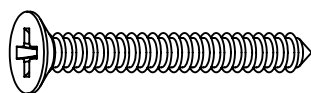

TORNILLO ARMADOR
7x50 (C)
CANTIDAD: 8

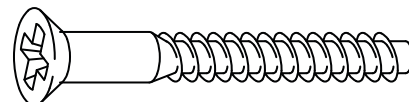

CLAVOS 8x20
CANTIDAD: 80

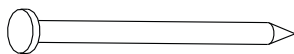

CONJUNTO MINI FIX
CANTIDAD: 4

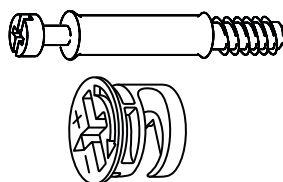

BISAGRA
CANTIDAD: 4

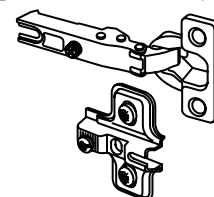

MANIJA
CANTIDAD: 4

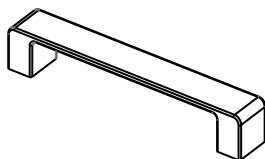

SOPORTE PERCHERO
CANTIDAD: 2

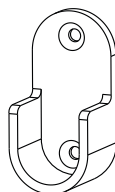

PERCHERO
CANTIDAD: 1

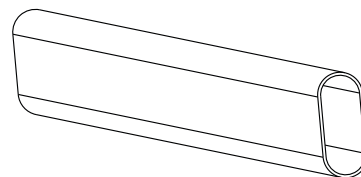

H VINCULANTE
CANTIDAD: 1



SACHE COLA
CANTIDAD: 1



HERRAMIENTAS NECESARIAS NO PROVISTAS

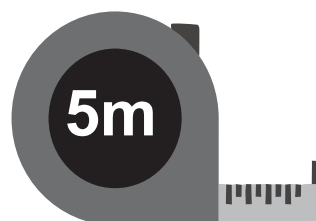
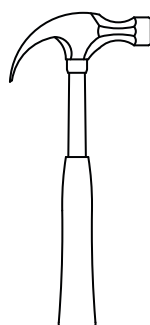
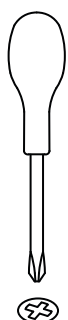

1

Colocar los costados (CD y CI) en la base (B) vincularlos con un tornillo armador y dos tarugos por costado

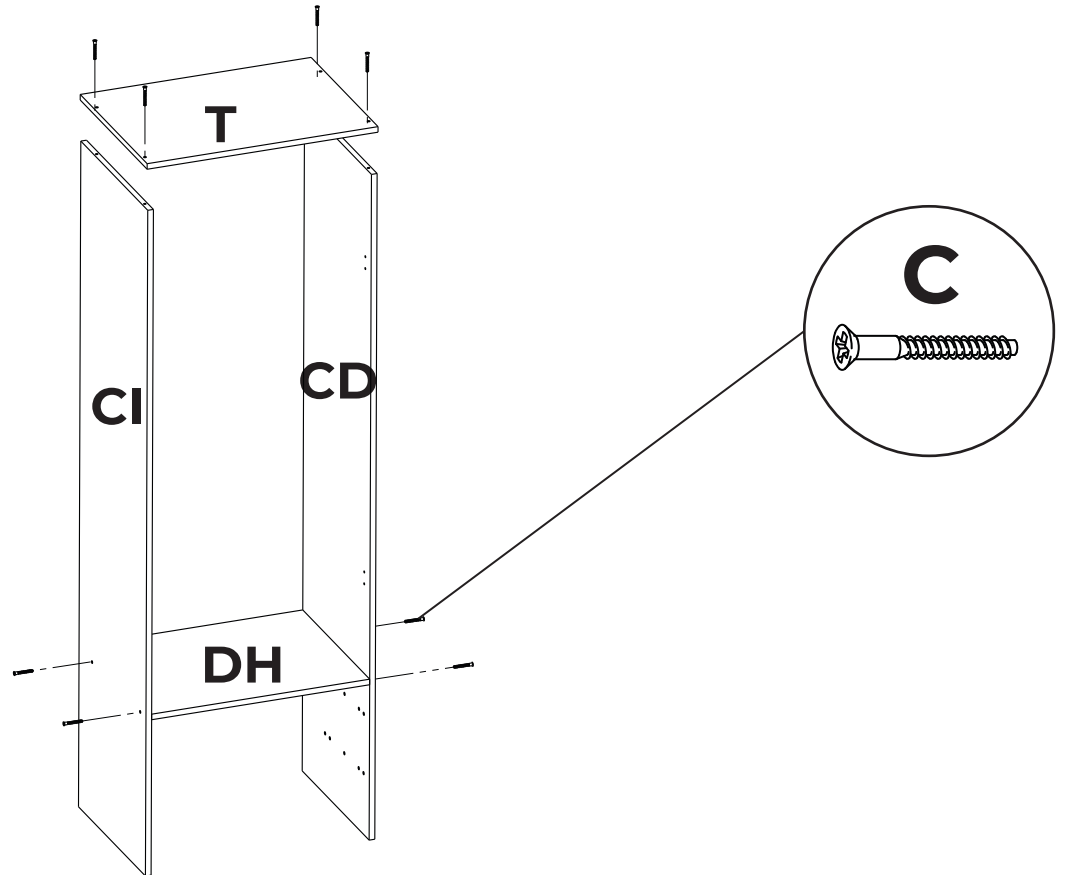
**2**

Colocar los zocalos (Z) con las L plasticas. Luego clavar los fondos (FO) colocando los clavos aproximadamente cada 10cm. Unir los fondos con la h vinculante. Luego clavar tambien los regatones como se muestra a continuacion.

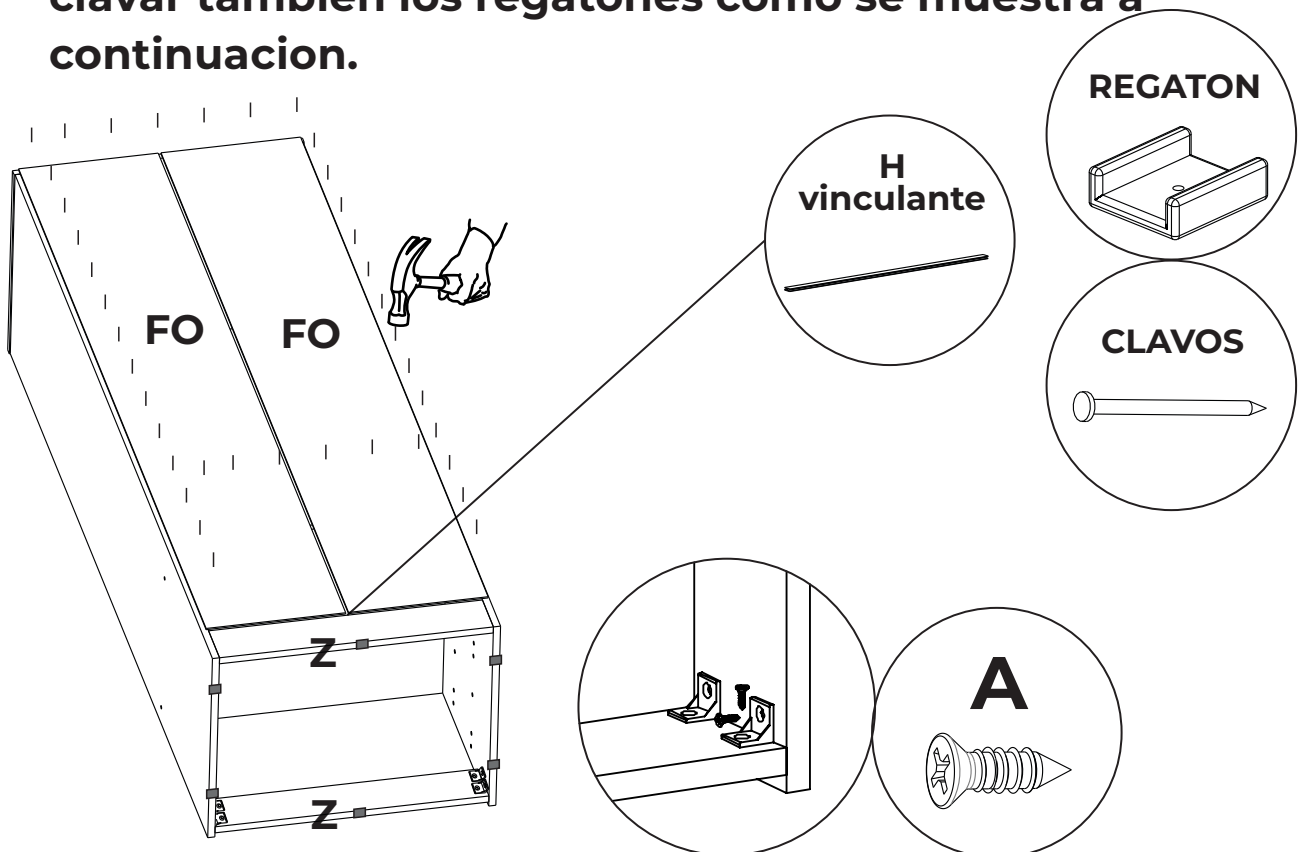

3 Armar la estructura del cajon como se muestra a continuacion uniendo el frente cajon (FC), con los costados del cajon (CC) y estos con el contra frente cajon (CFC). Luego colocar la manija con el tornillo correspondiente.

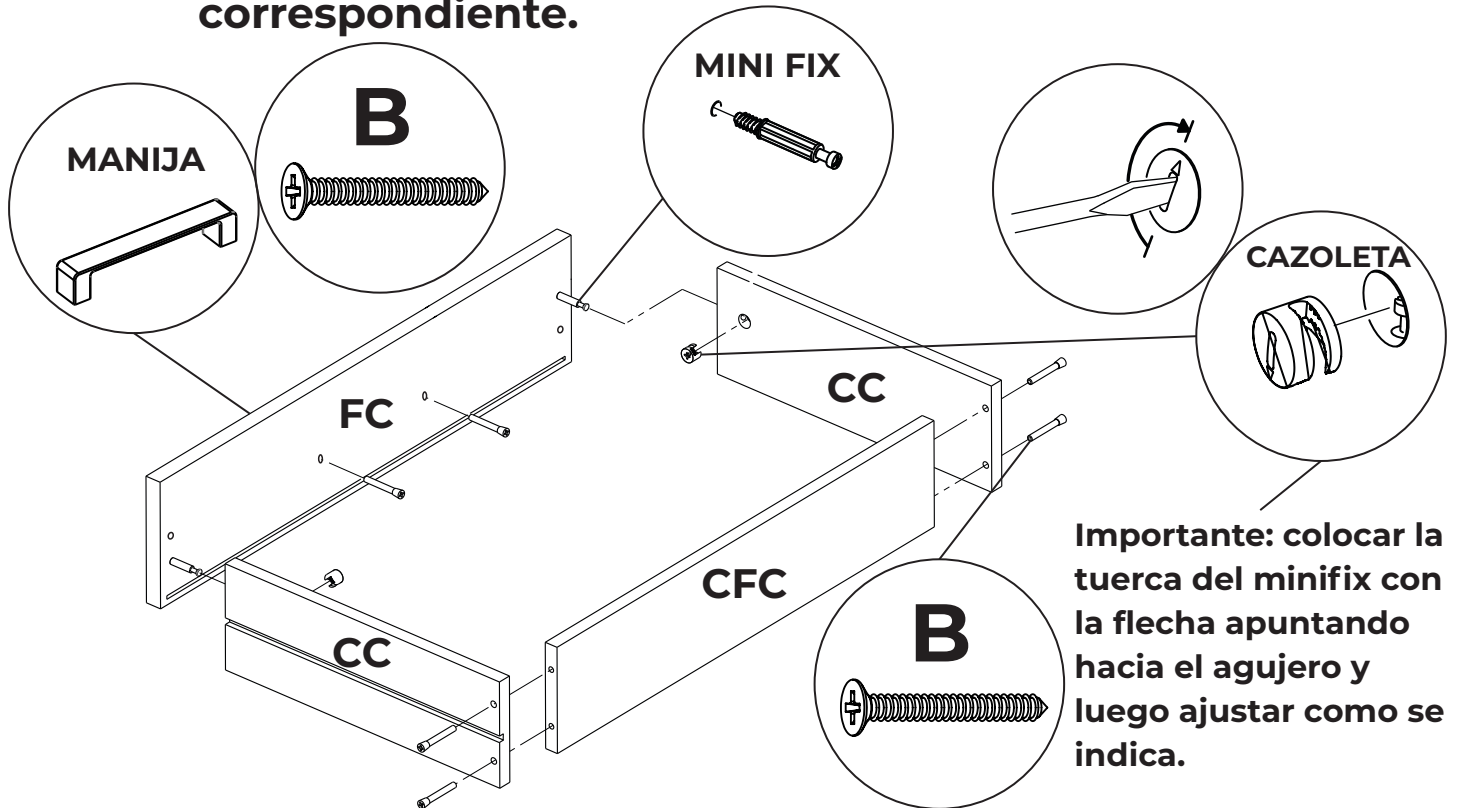

4 Colocar el fondo de cajon y clavar para afirmar las partes.

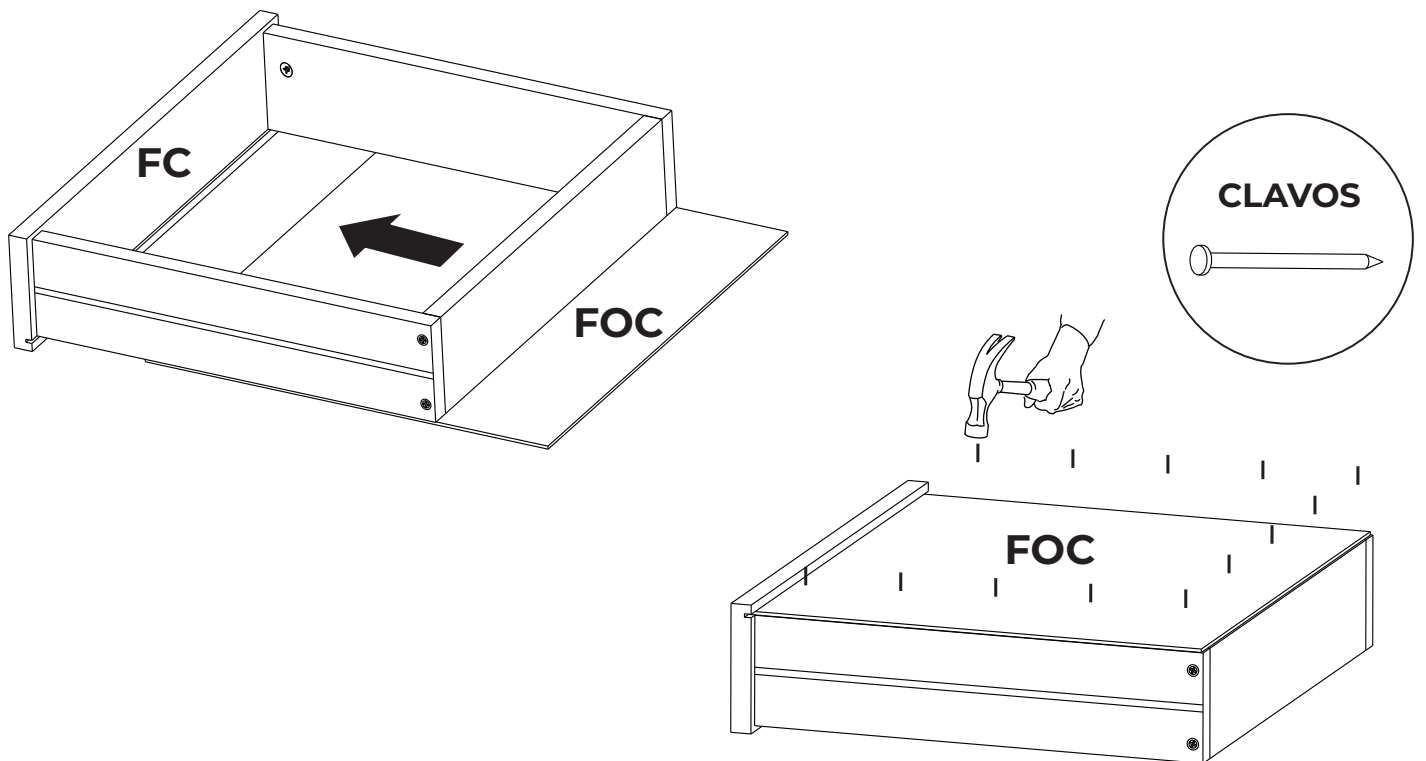

5

Colocar el juego de colizas donde se ubicaran los cajones. Previamente encolar los agujeros que alojan las colizas.

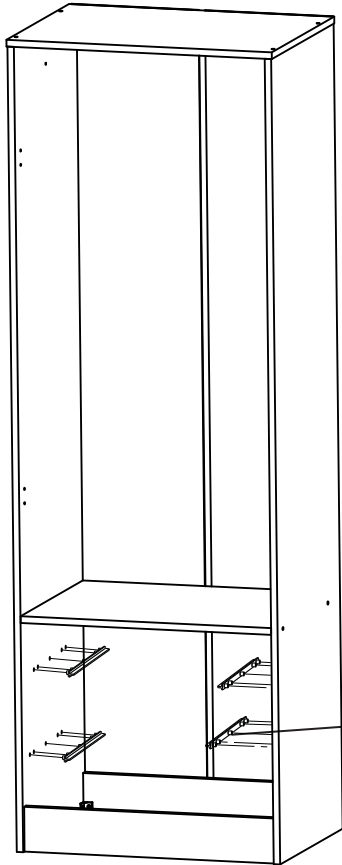

SACHE DE COLA



COLIZAS

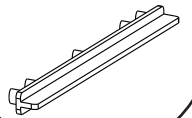

6

Colocar las bisagras en las puertas (PG-PCH) y los tiradores como se indican a continuacion con los tornillos indicados.

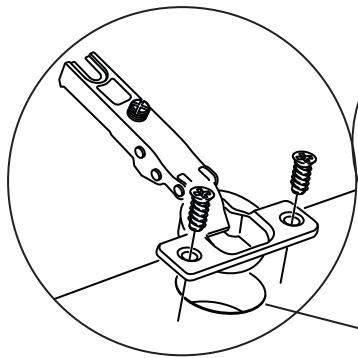

A

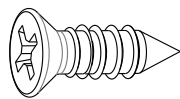

PG

MANIJAS

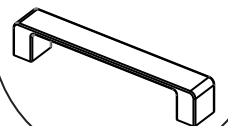

PCH

B

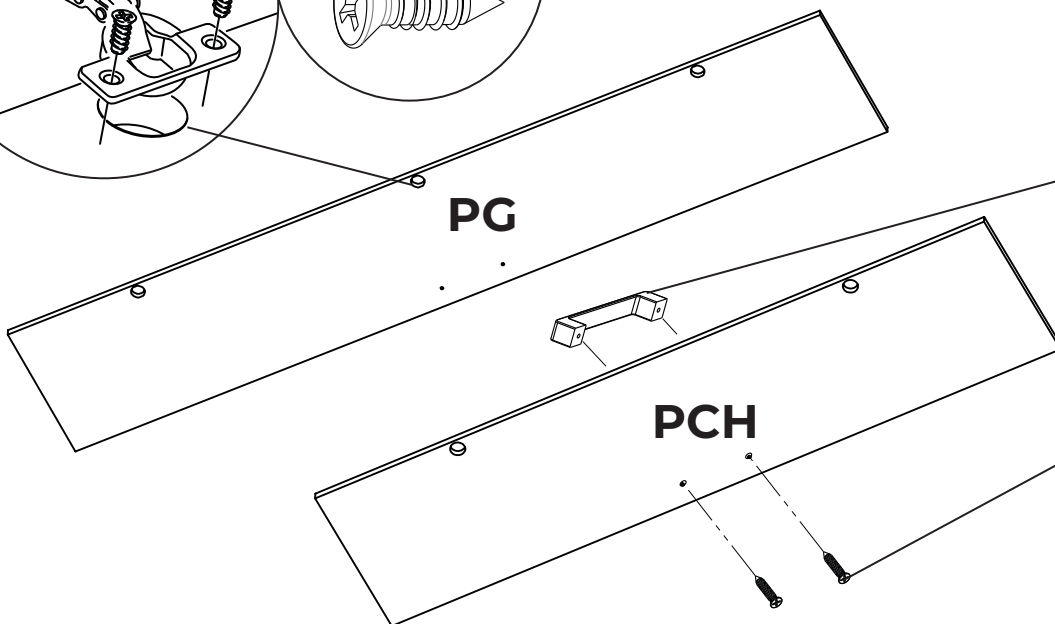

7 Colocar las puertas con las bisagras como se indica a continuación. Luego colocar el soporte de perchero en ambos lados para poder apoyar el perchero.

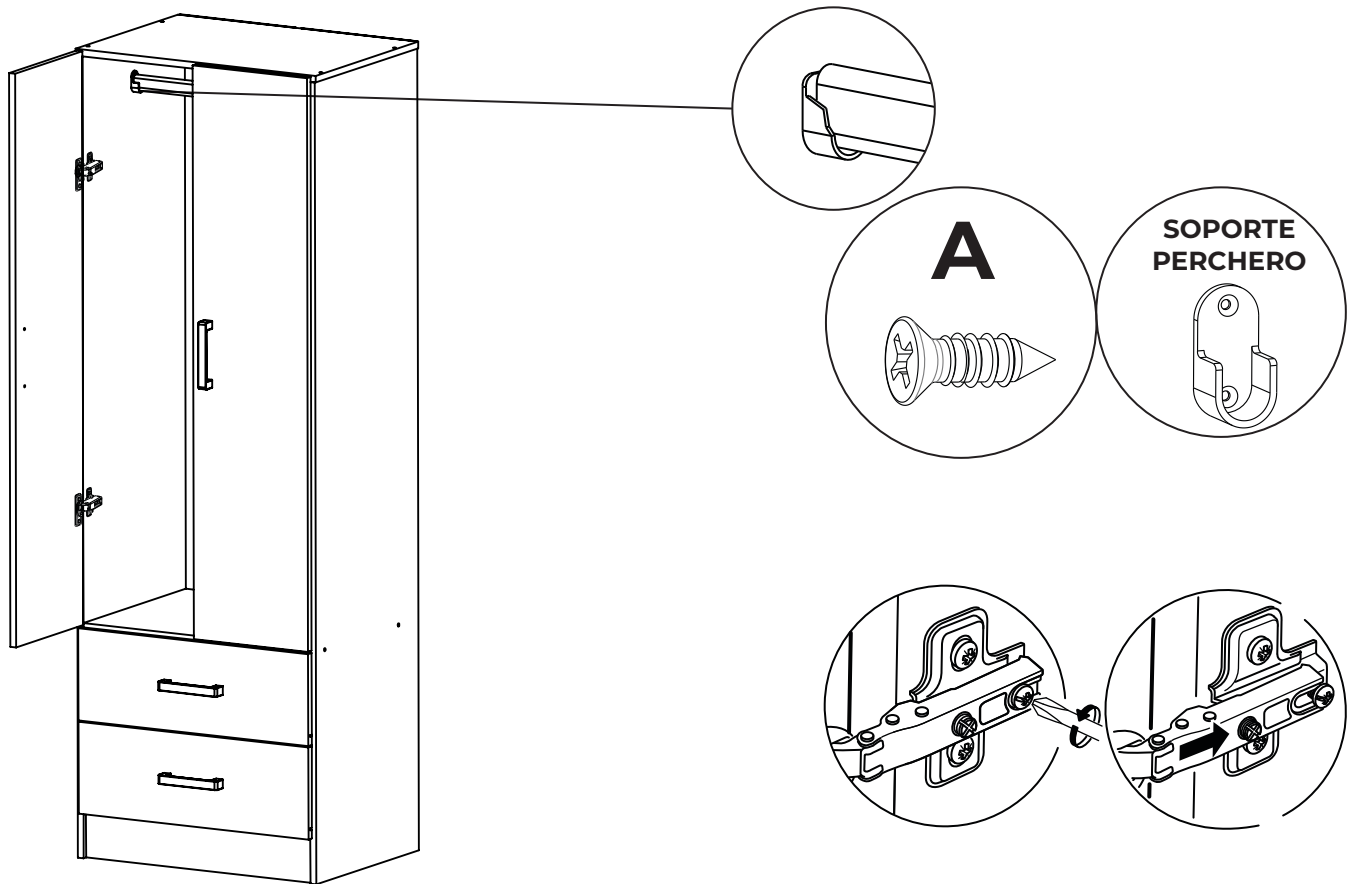

Regulación de bisagras

