

DESPENSERO

Instructivo de Armado D062

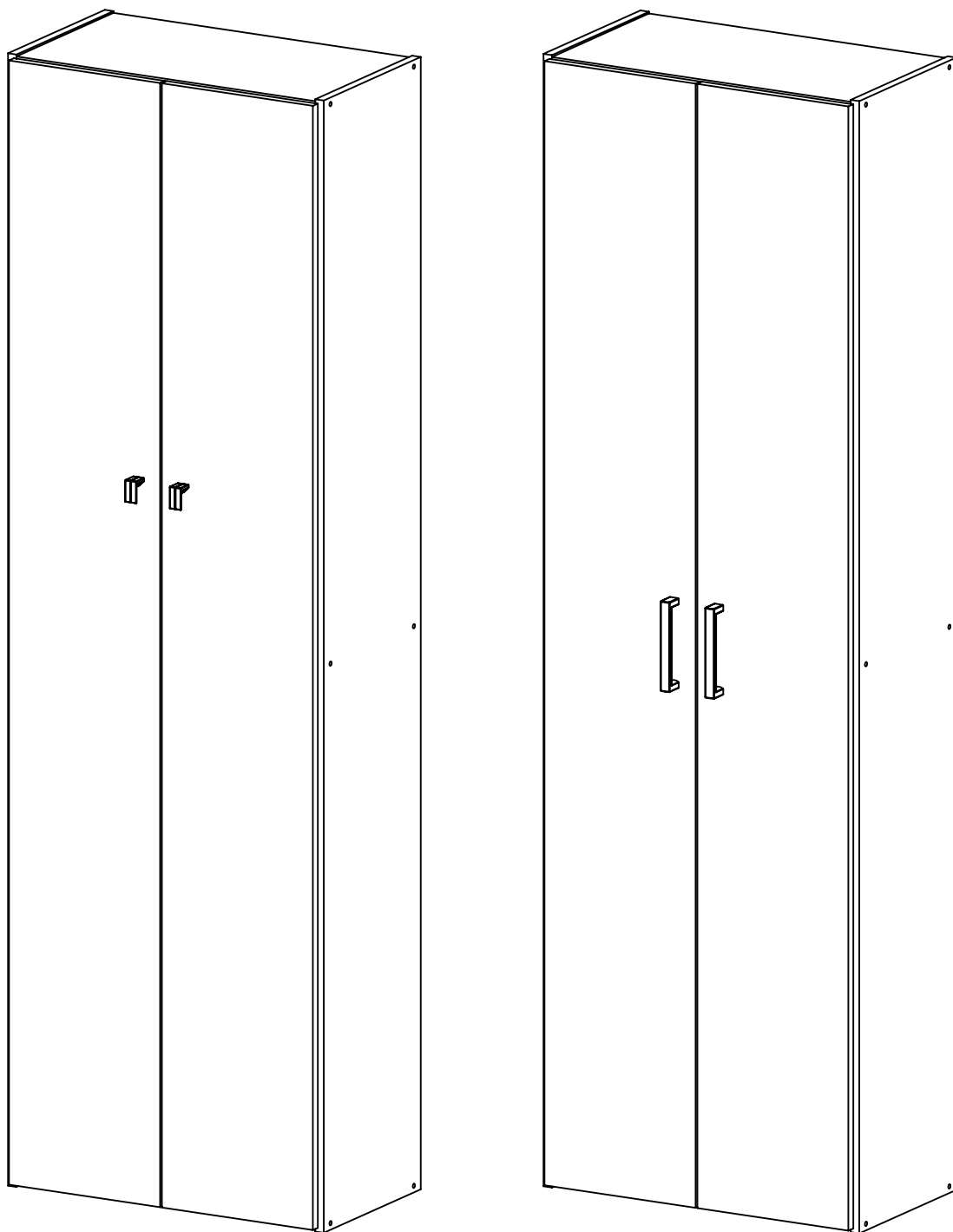

Nota: con su producto, podrá llegarle una manija
barral en lugar de tiradores plásticos.

Rev. 2-05/09/2023

DIELFE[®]

Fabricamos tu mueble

ESCANEA Y MIRA EL VIDEO DE ARMADO



✉ posventa@dielfe.com.ar

📌 [dieflemuebles](#)

📘 www.facebook.com/dielfe

📷 [dielfemuebles](#)

www.dielfe.com.ar

Industria Argentina

COMPONENTES

COSTADO (C)
CANTIDAD: 2

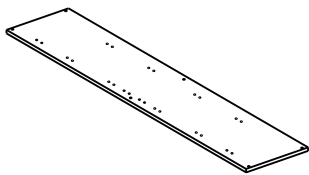

DIVISOR TAPA-BASE (DTB)
CANTIDAD: 3

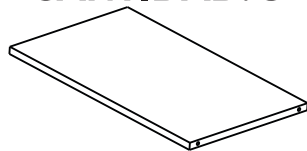

ESTANTE (E)
CANTIDAD: 2

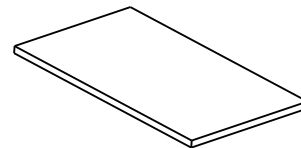

PUERTA (PI)
CANTIDAD: 1

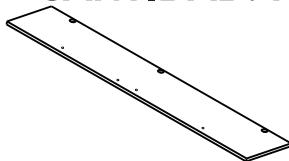

PUERTA (PD)
CANTIDAD: 1

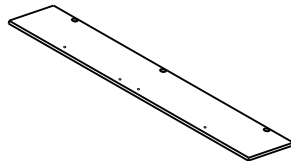

FONDO (FO)
CANTIDAD: 2

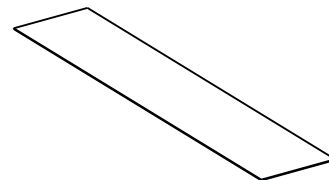

Nota: Los bordes pintados en gris hacen referencia a los filos de la melamina.

HERRAJES

CLAVOS 8x20
CANTIDAD: 46

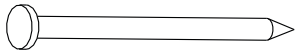

BASE ANTIDESLIZANTE
CANTIDAD: 4

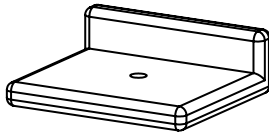

SOPORTE METALICO
5,5 (SM)
CANTIDAD: 8

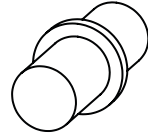

TORNILLO 3,5x14 (A)
CANTIDAD: 24

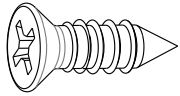

TORNILLO 3,5x30 (B)
CANTIDAD: 4



TORNILLO ARMADOR
7x50 (C)
CANTIDAD: 12

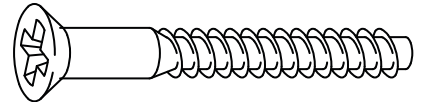

BISAGRA 26MM
CANTIDAD: 6

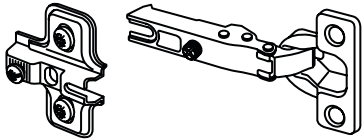

TIRADOR PLASTICO
CANTIDAD: 2

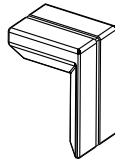

"H" VINCULANTE
CANTIDAD: 1



MANIJA BARRAL
CANTIDAD: 2

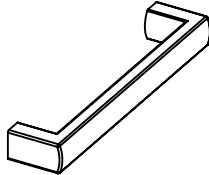

HERRAMIENTAS NECESARIAS NO PROVISTAS

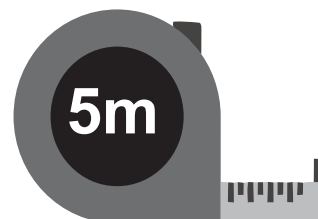
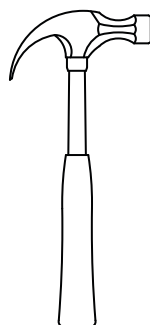
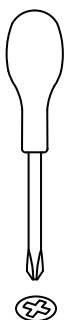

1

Armar la estructura del mueble apoyando el borde con canto de las piezas en el suelo para lograr que quede correctamente.

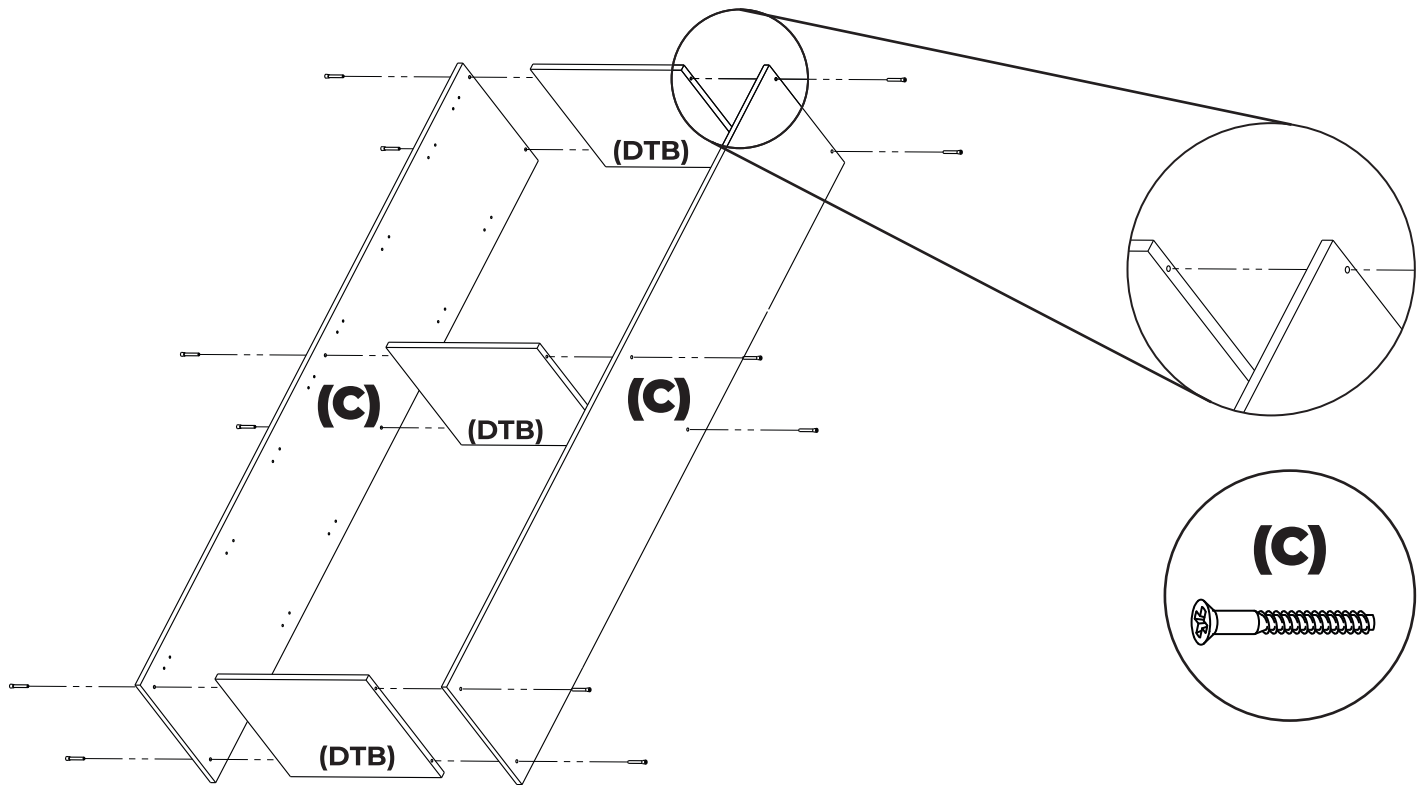

2

Vincular los dos fondos (FO) con la H vinculante para luego centrar y sujetar colocando un clavo cada 10cm aprox.

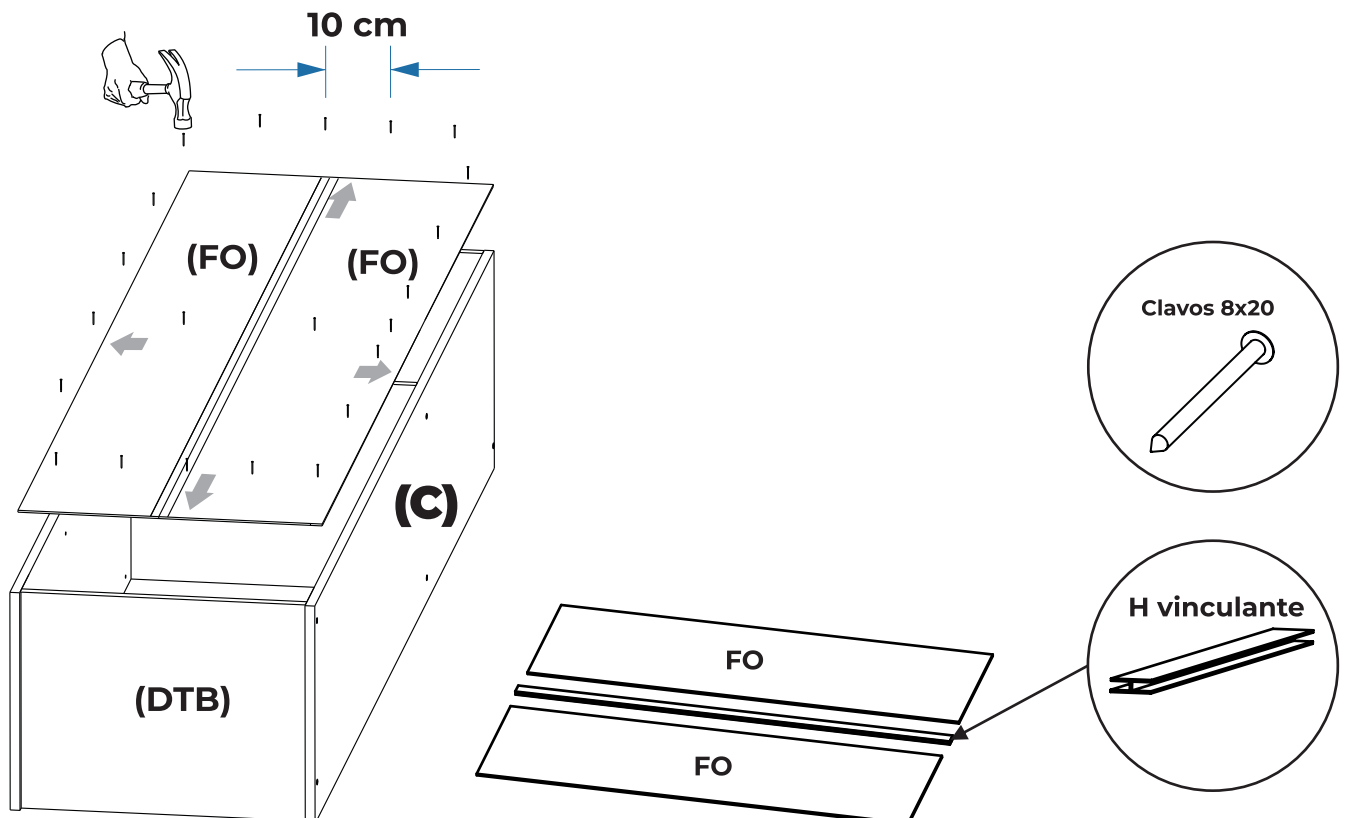

3 Colocar y clavar las bases antideslizantes las cuales van a hacer de apoyo con el suelo.

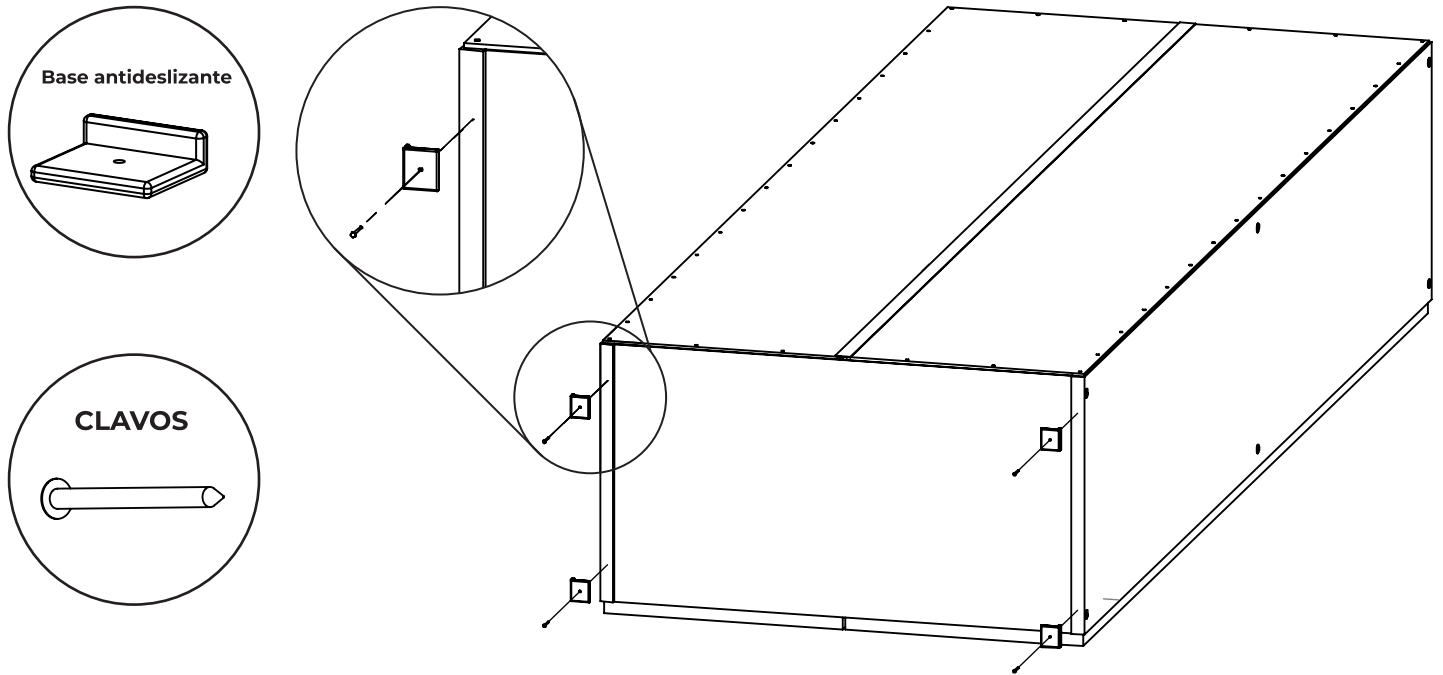

4 Colocar las bisagras y los tiradores en las puertas (PD). Antes de colocar el tirador se debe tener en cuenta de que lado se va abrir la puerta.

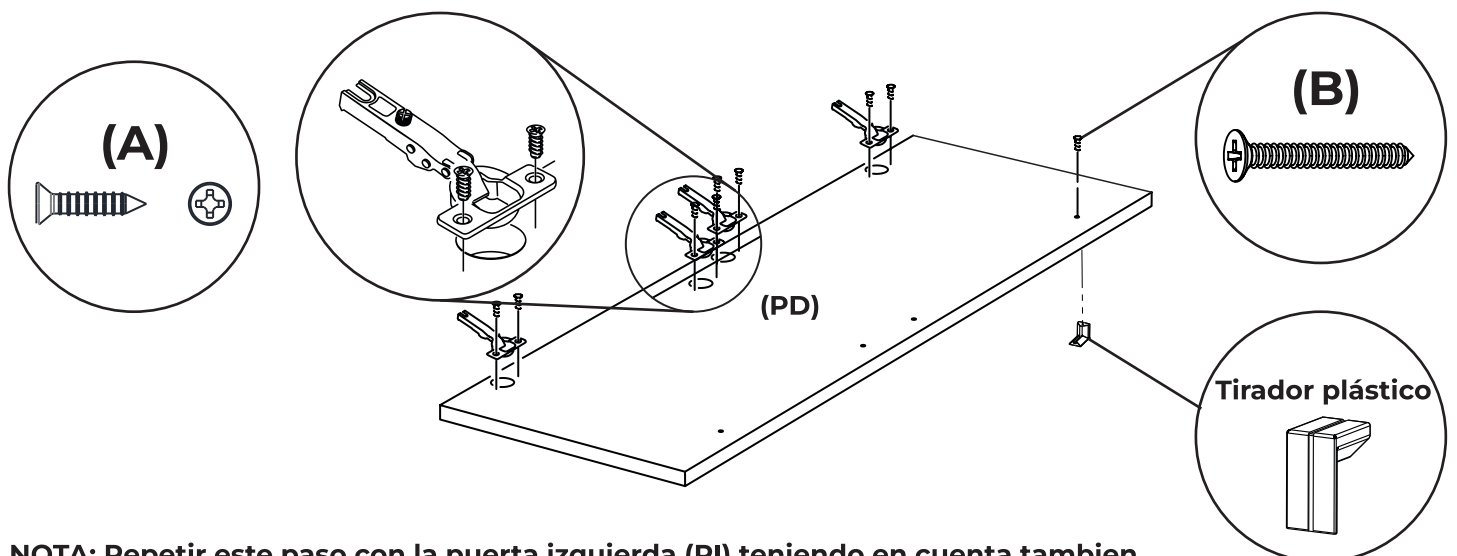

NOTA: Repetir este paso con la puerta izquierda (PI) teniendo en cuenta tambien el lado de apertura de la puerta

- 5** Colocar las bases de las bisagras en el interior del mueble. Antes de colocarlas tener en cuenta donde se desea ubicar cada puerta.

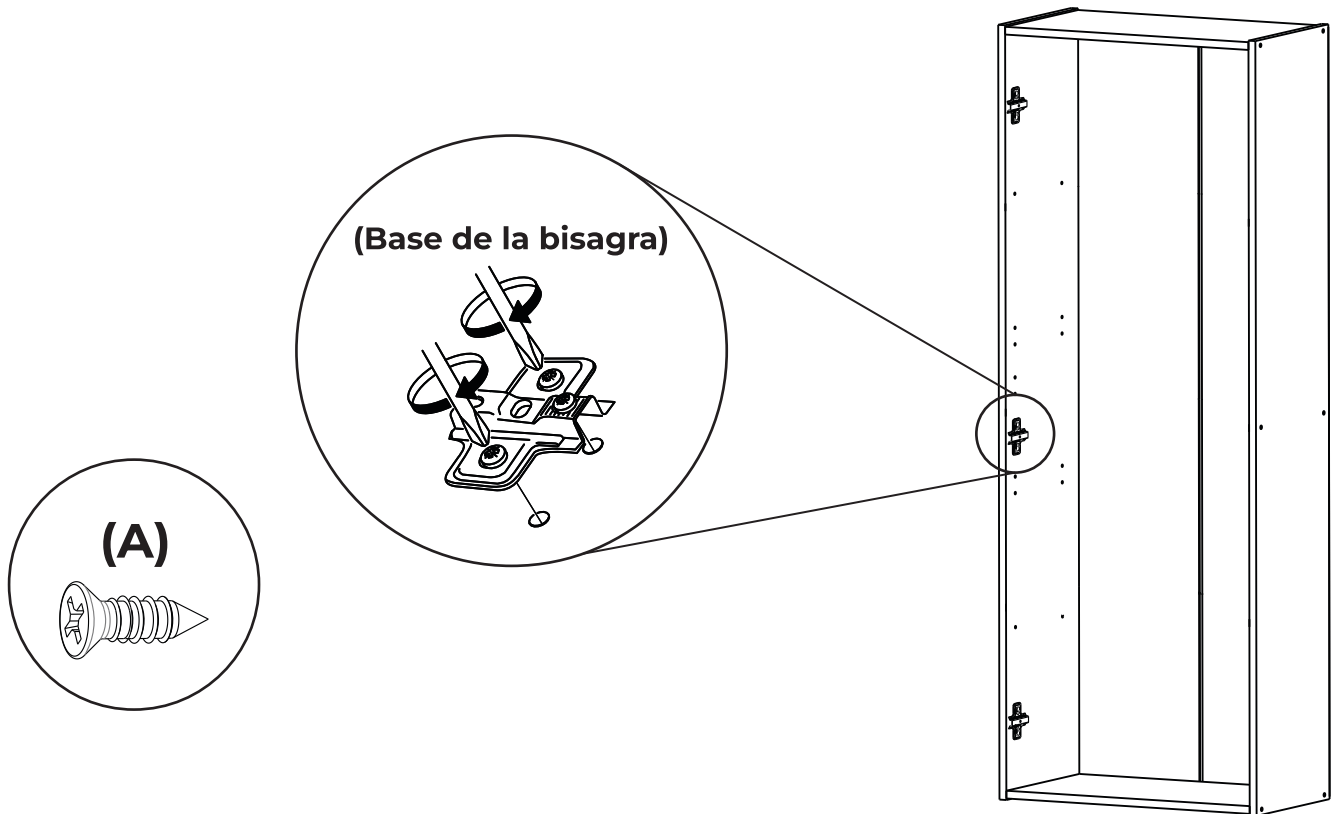

- 6** Colocar los soportes metalicos (SM) en los agujeros correspondientes para luego apoyar los estantes en los mismos.

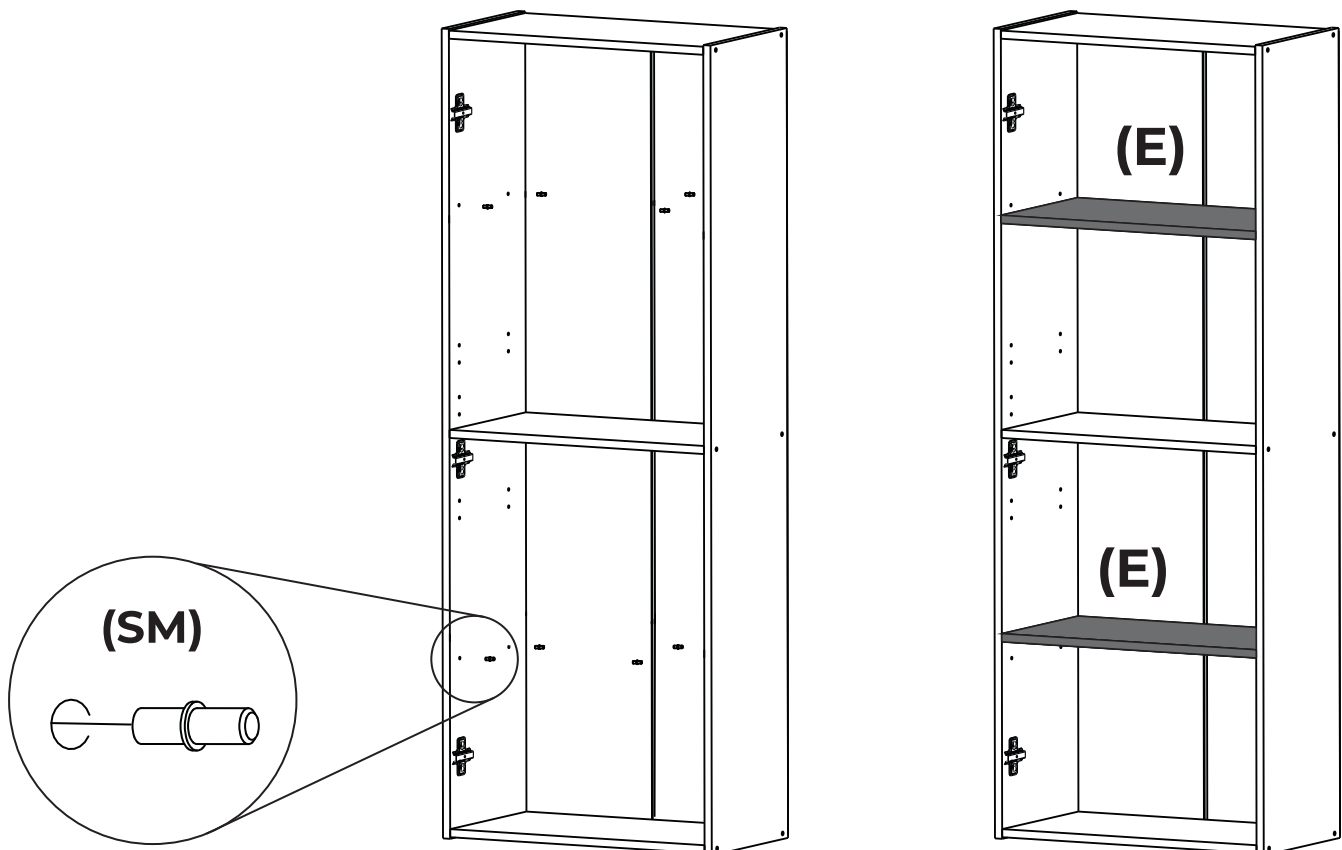

7 Colocar las puertas en el mueble.

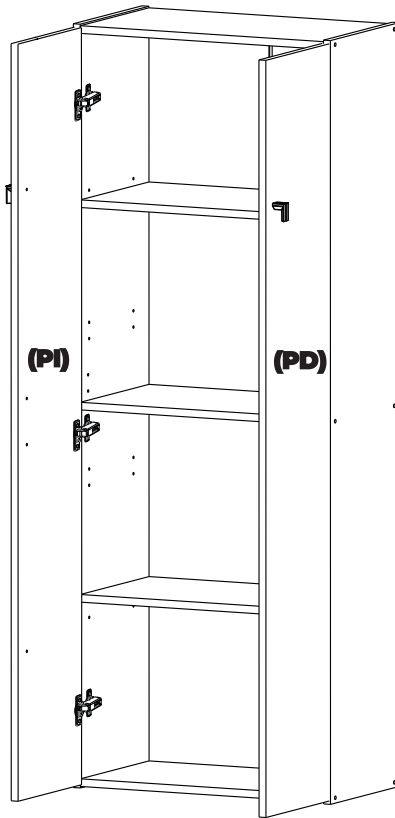
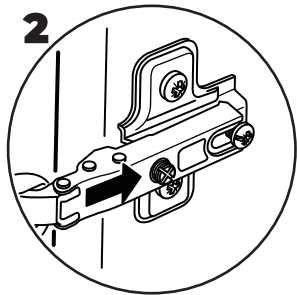
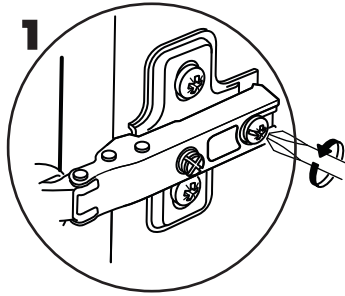

Regulacion de bisagras

