

ALACENA

Instructivo de Armado CMA060

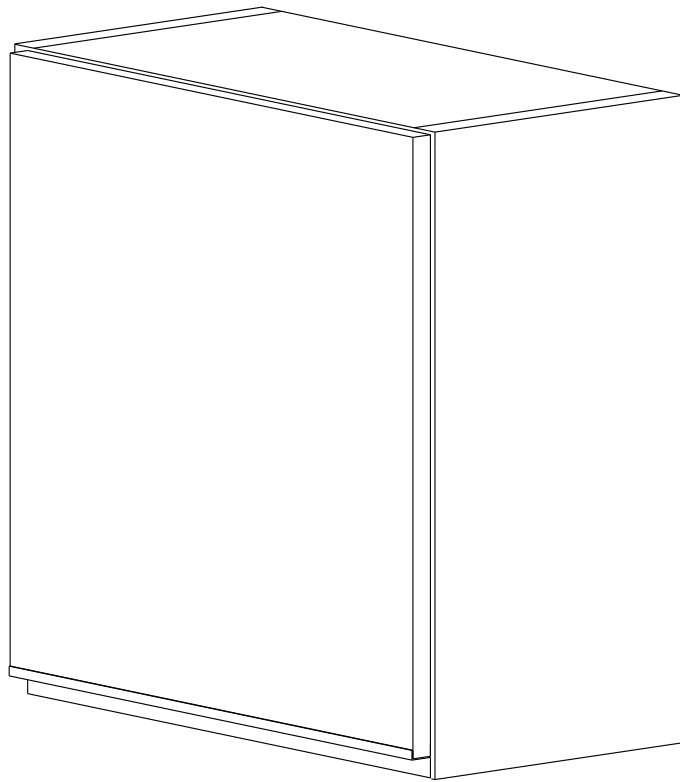

ESCANEA Y MIRA EL VIDEO DE ARMADO



✉ posventa@dielfe.com.ar

📌 [dieflemuebles](#)

📘 www.facebook.com/dielfe

📷 [dielfemuebles](#)

www.dielfe.com.ar

Industria Argentina

COMPONENTES

TAPA BASE (TB)
CANTIDAD: 2

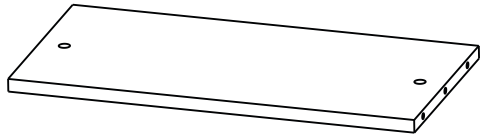

ESTANTE (E)
CANTIDAD: 1

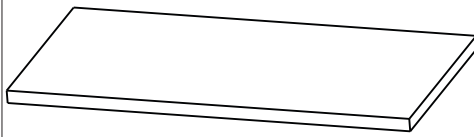

COSTADO (C)
CANTIDAD: 2

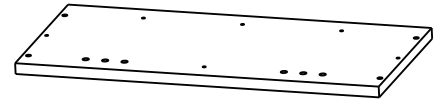

FONDO (FO)
CANTIDAD: 1



PUERTA (P)
CANTIDAD: 1



HERRAMIENTAS NECESARIAS NO PROVISTAS

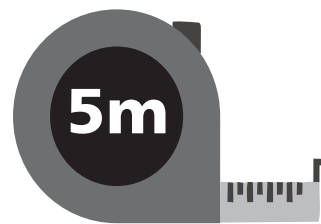
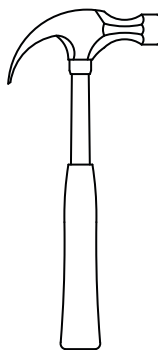
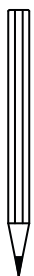
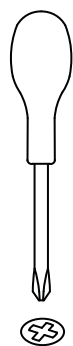

Nota: Los bordes pintados en gris hacen referencia a los filos de la melamina.

HERRAJES

MANIJA
CANTIDAD: 1

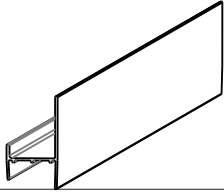

TAPA TORNILLO
CANTIDAD: 8

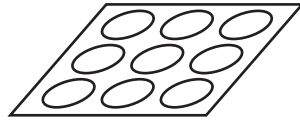

CLAVOS 8x20
CANTIDAD: 22

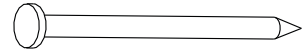

SOPORTE ESTANTE
CANTIDAD: 4

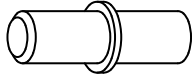

BISAGRA
CANTIDAD: 2

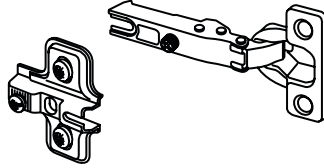

CONJUNTO MINI FIX
CANTIDAD: 4

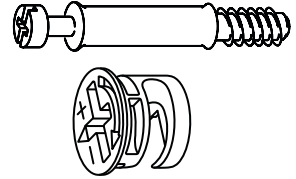

SOPORTE PARA COLCAR
CANTIDAD: 2

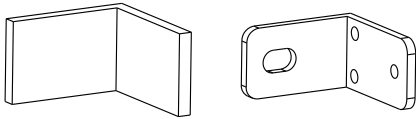

TACO NYLON
CANTIDAD: 4



SACHET COLA
CANTIDAD: 1



TARUGO 8x30
CANTIDAD: 8



TORNILLO 3,5x14 (A)
CANTIDAD: 12

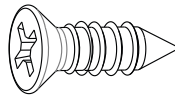

TORNILLO EURO
6X10 (B)
CANTIDAD: 4

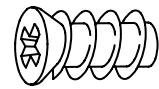

H VINCULANTE
CANTIDAD: 1



1

Colocar los herrajes en los costados (C). Colocar los tacos de nylon teniendo en cuenta de que lado se va a abrir la puerta, y en el contrario pegar las tapas adhesivas para cubrir los agujeros libres.

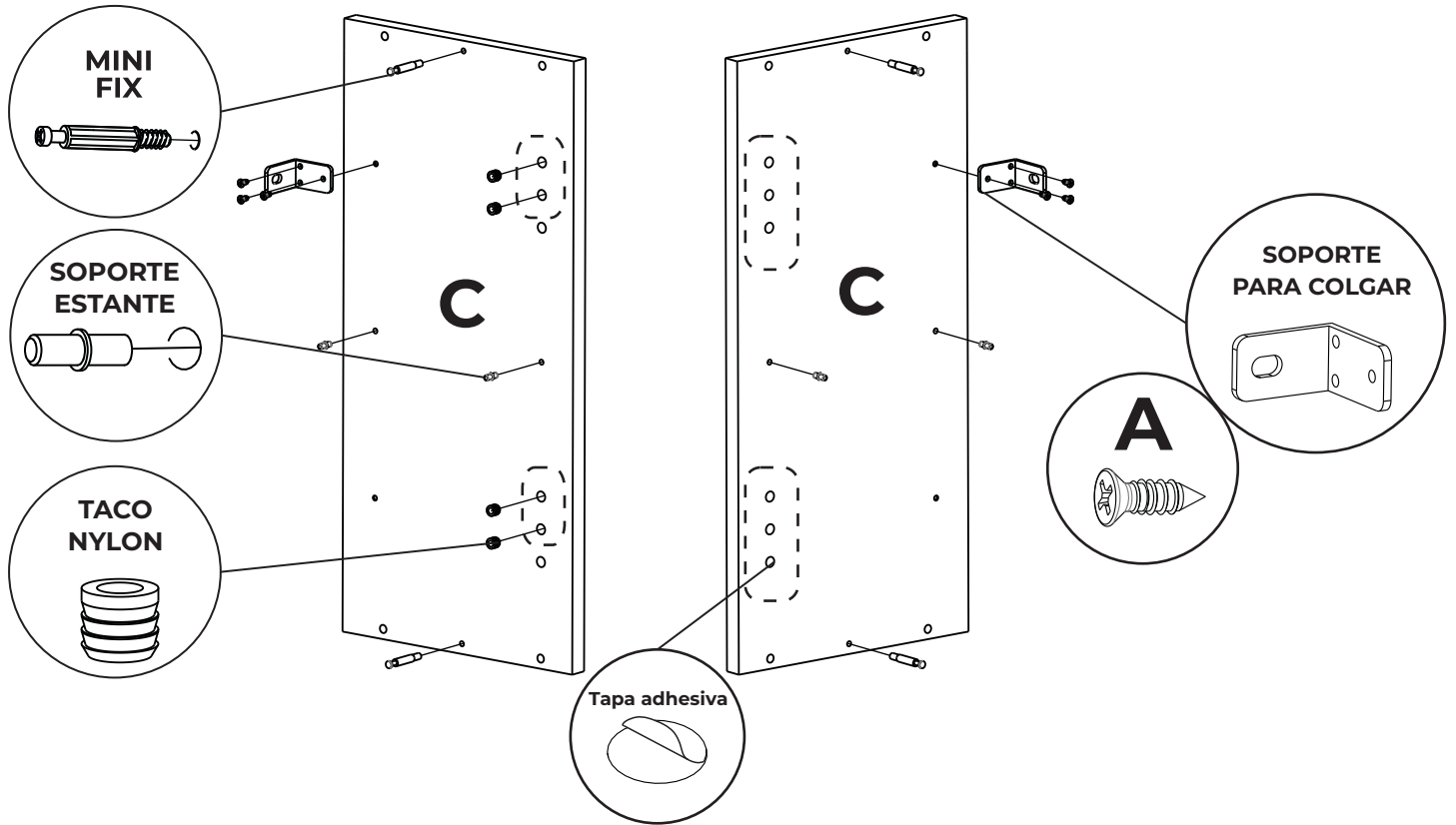

2

Encolar los orificios que alojaran los tarugos y posteriormente colocarlos en la tapa base (TB) para luego armar la estructura del mueble uniendo las tapa base (TB) junto con los costados (C).

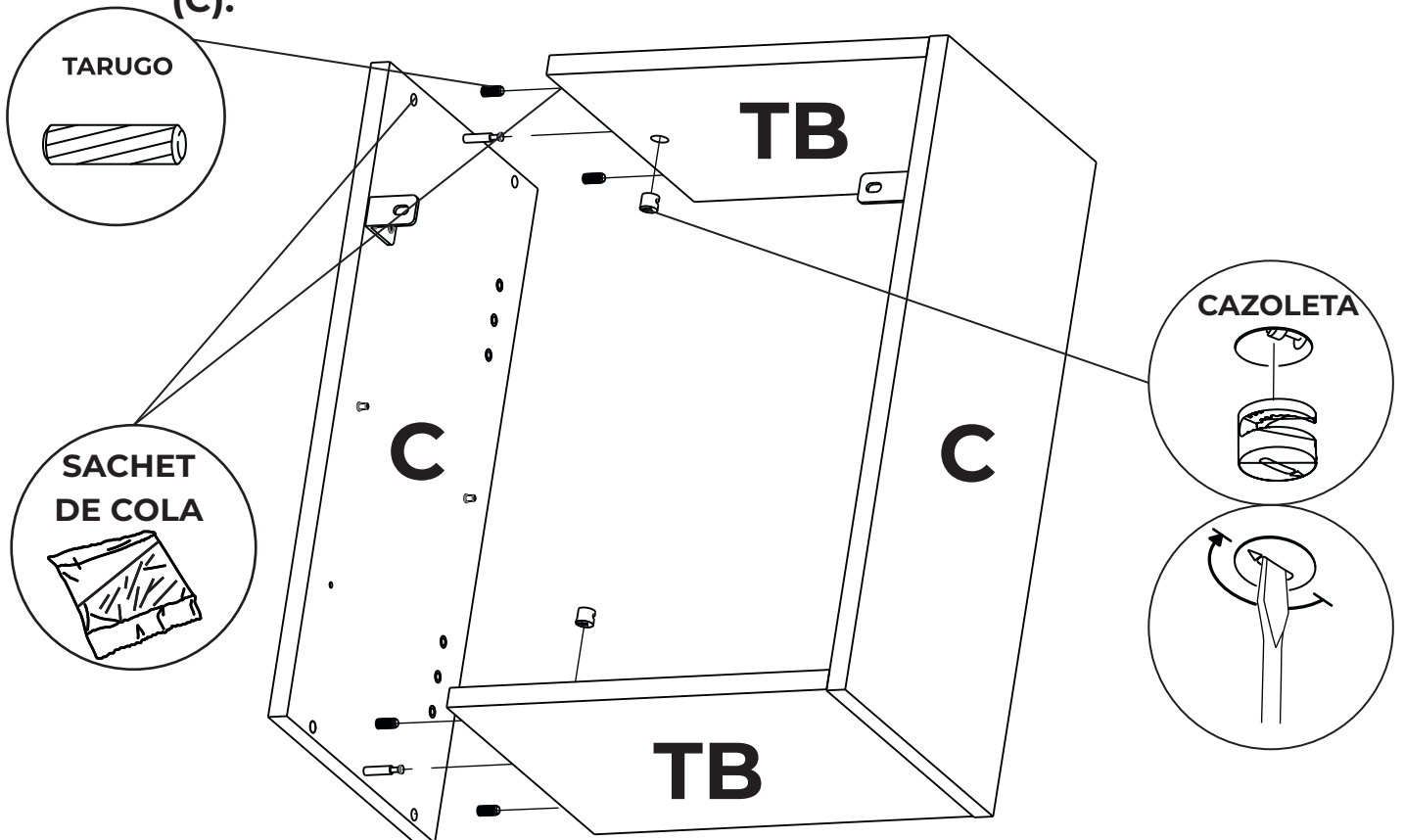

3

Centrar y clavar los fondos colocando los clavos cada 10cm aproximadamente.

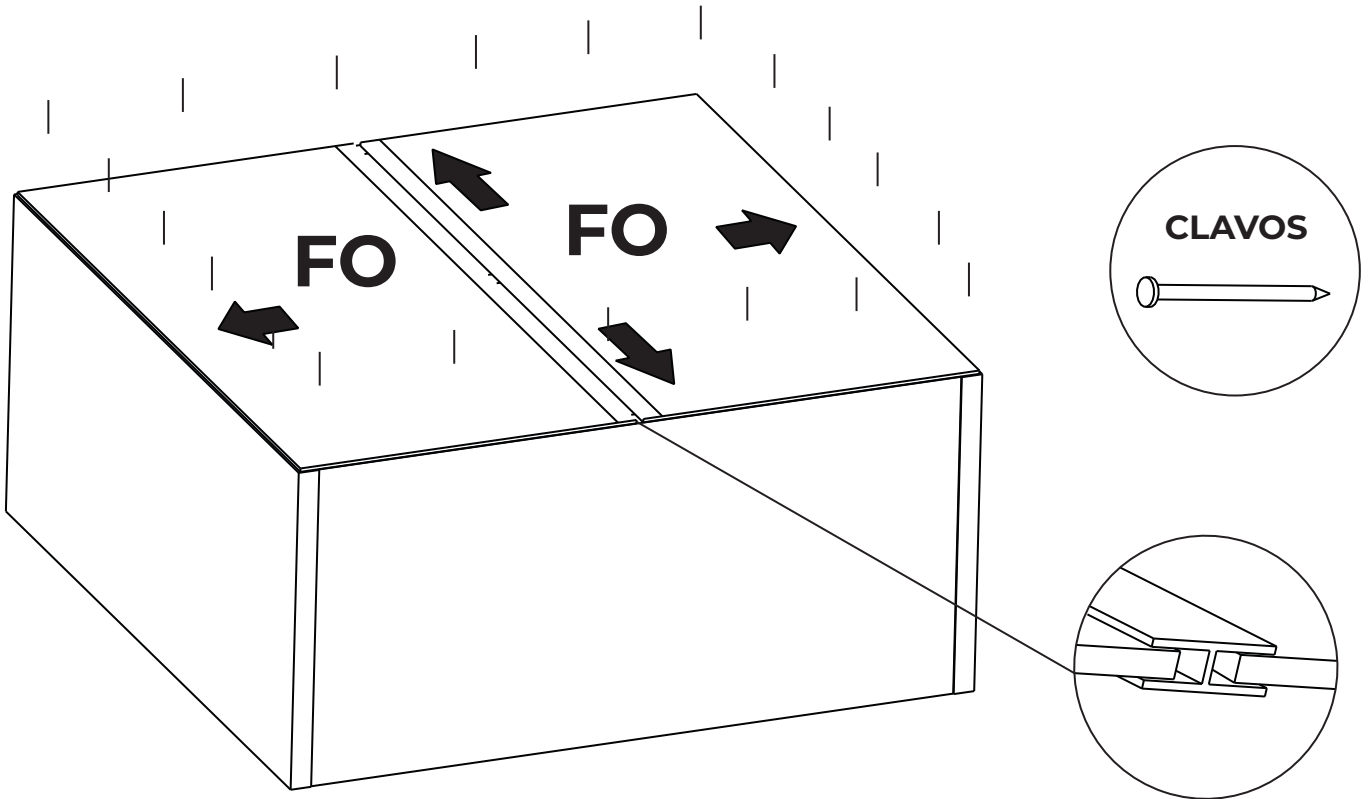

4

Colocar las manijas y las bisagras en las puertas (P). Tener en cuenta de que lado se va a abrir antes de realizar este paso.

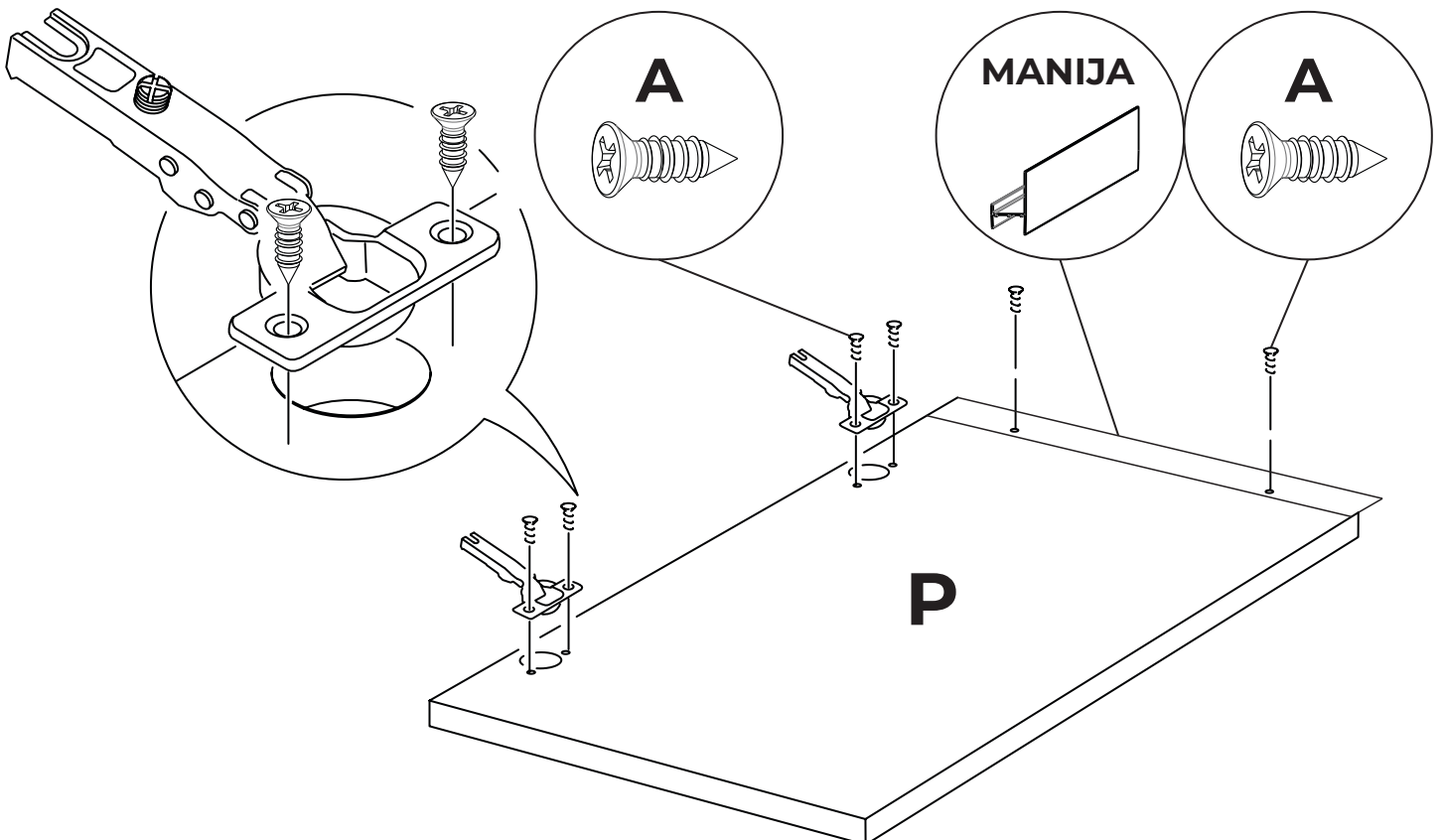

5 Colocar las bases de las bisagras con el tornillo correspondiente.

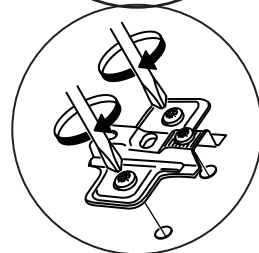
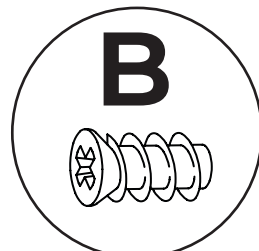
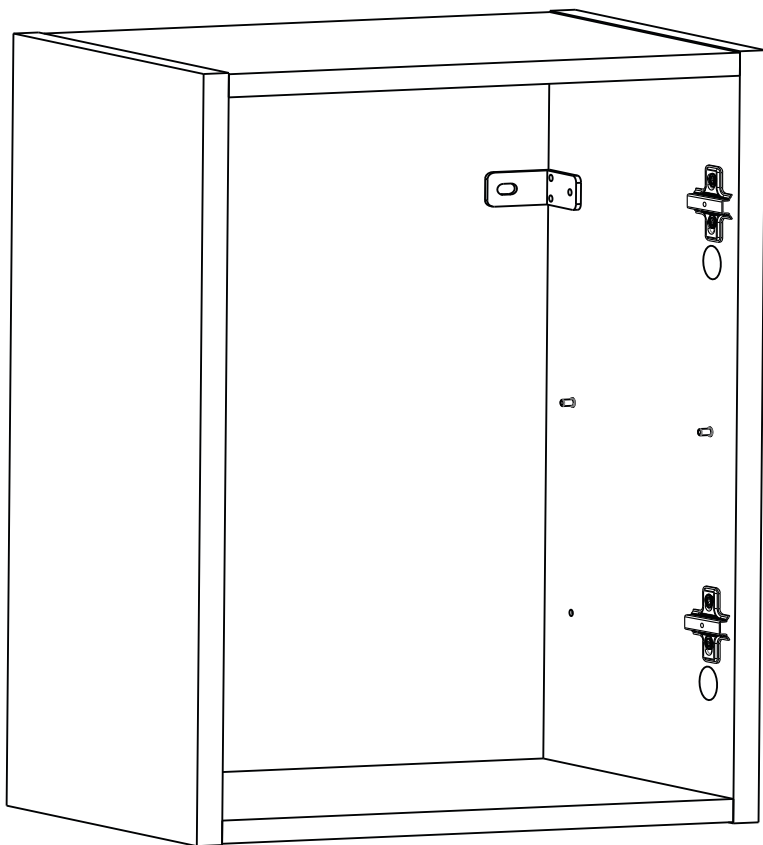

6 Colocar las puertas (P) en el ensamblaje uniendo las dos partes de las bisagras.

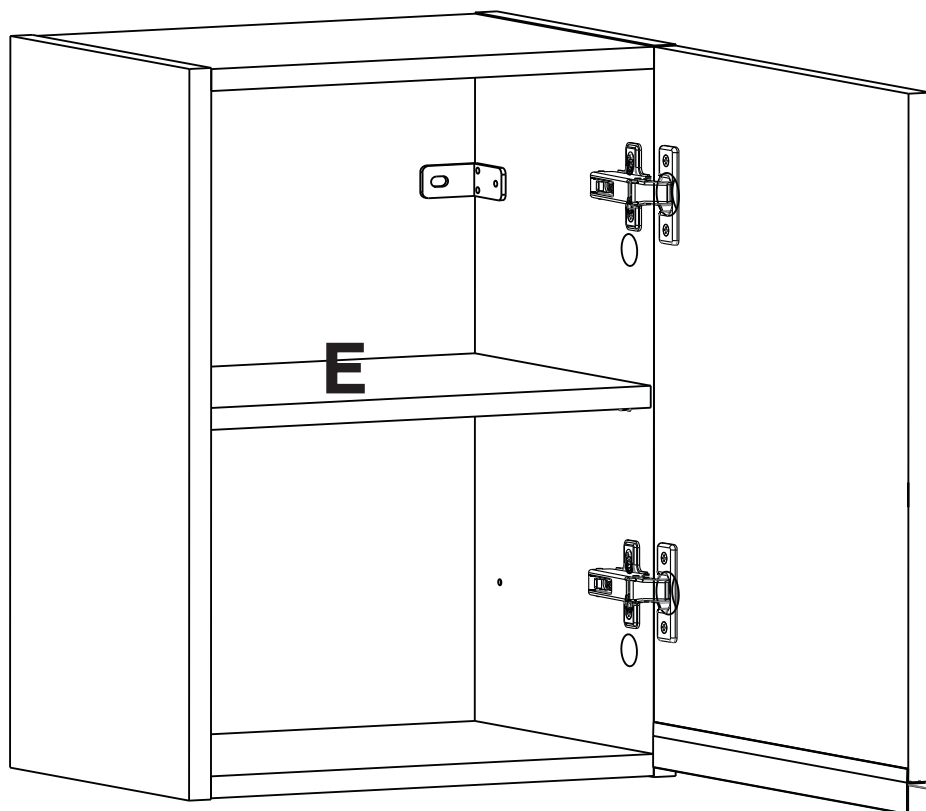
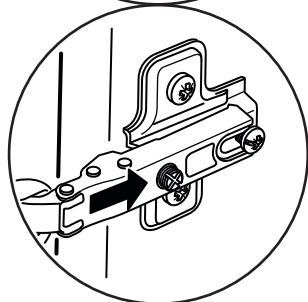
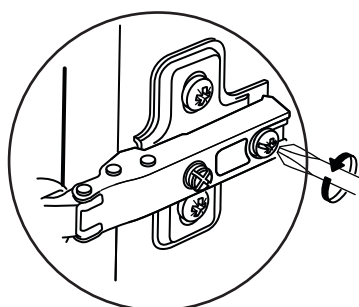

7

Colocar la alacena en la posición deseada y atornillar a la pared con el tornillo correspondiente (no incluido en el herraje), dependiendo del tipo de pared. Luego colocar las tapas plásticas en los soportes.

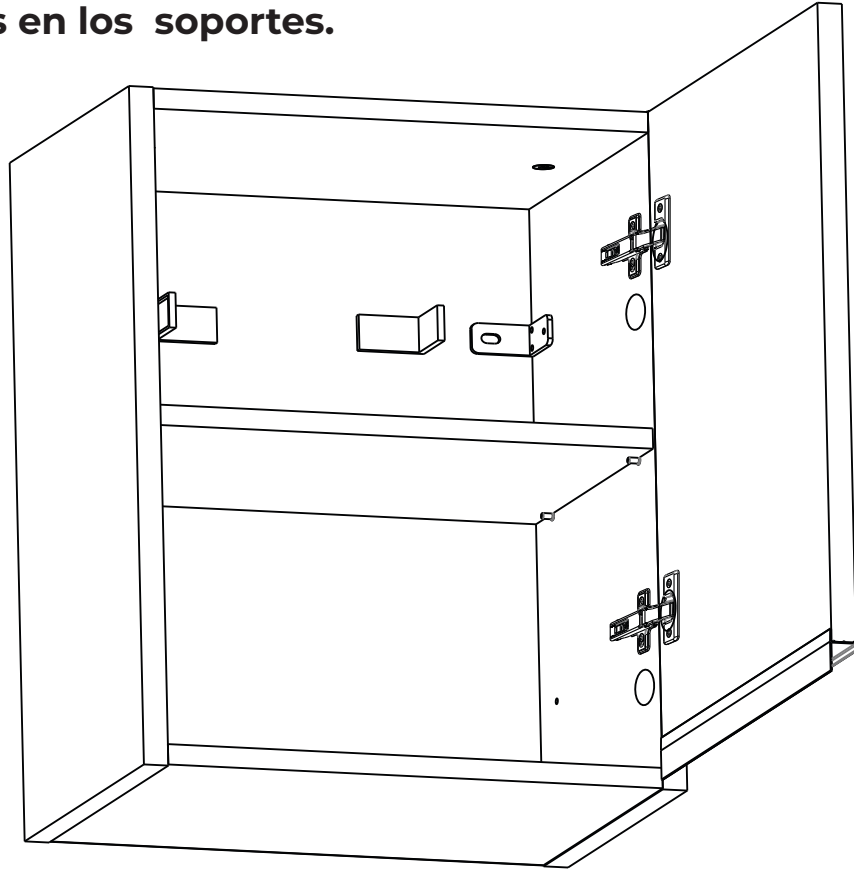

Regulación de bisagras

